

# Topic 6

## Sinusoidal Steady-State Analysis

Linear Systems and Circuit Applications

Óscar Barquero Pérez

Cartagena99

CLASES PARTICULARES, TUTORÍAS TÉCNICAS ONLINE  
LLAMA O ENVÍA WHATSAPP: 689 45 44 70

---

ONLINE PRIVATE LESSONS FOR SCIENCE STUDENTS  
CALL OR WHATSAPP:689 45 44 70

# Table of contents

- Introduction
- Sinusoidal sources
- Circuit elements in Sinusoidal steady state.
- Sinusoidal Response
- The Phasor
- Impedance and admittanceImpedancia y admitancia
- Phasor in R, L and CRelaciones fasoriales para R, L y C
- Sinusoidal steady state analysis
- Thèvenin and Norton equivalents in sinusoidal steady state.
- Power in sinusoidal steady state

Cartagena99

CLASES PARTICULARES, TUTORÍAS TÉCNICAS ONLINE  
LLAMA O ENVÍA WHATSAPP: 689 45 44 70

---

ONLINE PRIVATE LESSONS FOR SCIENCE STUDENTS  
CALL OR WHATSAPP:689 45 44 70

# Sinusoidal sources

Cartagena99

CLASES PARTICULARES, TUTORÍAS TÉCNICAS ONLINE  
LLAMA O ENVIA WHATSAPP: 689 45 44 70

---

ONLINE PRIVATE LESSONS FOR SCIENCE STUDENTS  
CALL OR WHATSAPP:689 45 44 70

# Sinusoidal Sources

- The sinusoidal sources provide with a sinusoidal voltaje or current

$$A \sin(\omega t + \phi) \text{ o } A \cos(\omega t + \phi)$$

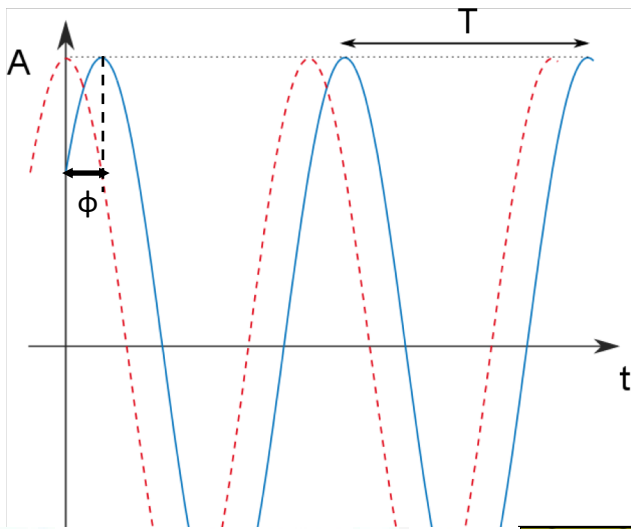
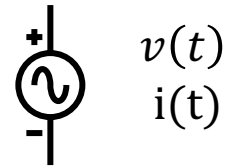

- $A$ : *máximo amplitude* [A,V]
- $T$ : period [s],  
 $t = nT, n \text{ integer} \rightarrow v(t + nT) = v(t)$
- Frequency
- $f = \frac{1}{T}$  [Hz]
- $\omega$ : angular frequency

$$\omega = \frac{2\pi}{T} = 2\pi f \text{ [rad/s]}$$

Cartagena99

CLASES PARTICULARES, TUTORÍAS TÉCNICAS ONLINE  
LLAMA O ENVÍA WHATSAPP: 689 45 44 70

---

ONLINE PRIVATE LESSONS FOR SCIENCE STUDENTS  
CALL OR WHATSAPP:689 45 44 70

# Sinusoidal sources

- A sinusoid can be expressed using sin or cos taking into account:

$$\sin(\phi) = -\cos(\phi + \frac{\pi}{2}) = \cos(\phi - \frac{\pi}{2})$$

$$\cos(\phi) = \sin(\phi + \frac{\pi}{2}) = -\sin(\phi - \frac{\pi}{2})$$

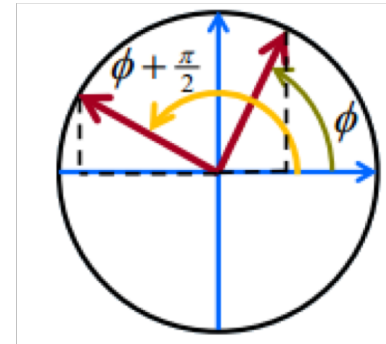

- The following relationships can be useful:

$$\sin(A \pm B) = \sin(A) \cos(B) \pm \cos(B) \sin(A)$$

Cartagena99

CLASES PARTICULARES, TUTORÍAS TÉCNICAS ONLINE  
LLAMA O ENVÍA WHATSAPP: 689 45 44 70

---

ONLINE PRIVATE LESSONS FOR SCIENCE STUDENTS  
CALL OR WHATSAPP:689 45 44 70

# Sinusoidal sources

- The two following generic signals  $v_1(t) = \sin(\omega t)$  and  $v_2(t) = \sin(\omega t + \phi)$  as a function of the argument can be observed:
  - When  $\phi > 0 \rightarrow v_2(t)$  is ahead (advanced) (see figure)
  - When  $\phi < 0 \rightarrow v_2(t)$  is delayed
  - If  $\phi = 0$  both signals are in phase.

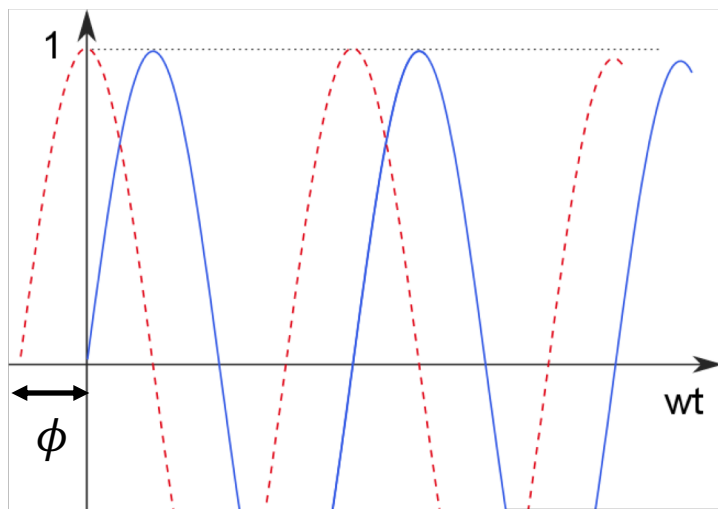

- The sin and cosine signals are separated by a phase of  $\phi = \pi/2$ .
  - It is possible to transform one into the other by just adding the proper amount of phase.
  - The sine is delayed with respect to the cosine.

$$\cos(\omega t) = \sin\left(\omega t + \frac{\pi}{2}\right)$$

CLASES PARTICULARES, TUTORÍAS TÉCNICAS ONLINE  
LLAMA O ENVÍA WHATSAPP: 689 45 44 70

---

ONLINE PRIVATE LESSONS FOR SCIENCE STUDENTS  
CALL OR WHATSAPP: 689 45 44 70

Cartagena99

# Sinusoidal sources

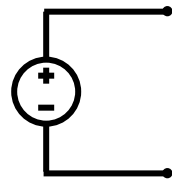

$$v_g(t) = V_m \cos(\omega t + \phi_v) [V]$$

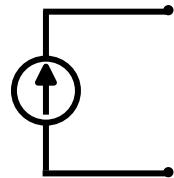

$$i_g(t) = I_m \cos(\omega t + \phi_i) [A]$$

Cartagena99

CLASES PARTICULARES, TUTORÍAS TÉCNICAS ONLINE  
LLAMA O ENVÍA WHATSAPP: 689 45 44 70

---

ONLINE PRIVATE LESSONS FOR SCIENCE STUDENTS  
CALL OR WHATSAPP:689 45 44 70

# Sinusoidal Sources

- **Example 1:** find the amplitude, initial phase, period and frequency of the following sinusoidal voltaje:  $v(t) = 12\cos(50t + 10^\circ)$ .

- **Example 2:** finde the phase difference between the following signals:

$$v_1(t) = -10\cos(\omega t + 50^\circ) \text{ y } v_2(t) = 12\sin(\omega t - 10^\circ).$$

Cartagena99

CLASES PARTICULARES, TUTORÍAS TÉCNICAS ONLINE  
LLAMA O ENVIA WHATSAPP: 689 45 44 70

---

ONLINE PRIVATE LESSONS FOR SCIENCE STUDENTS  
CALL OR WHATSAPP:689 45 44 70



# Circuit elements in sinusoidal steady-state

V-i and i-V relationship in passive elements

Cartagena99

CLASES PARTICULARES, TUTORÍAS TÉCNICAS ONLINE  
LLAMA O ENVIA WHATSAPP: 689 45 44 70

---

ONLINE PRIVATE LESSONS FOR SCIENCE STUDENTS  
CALL OR WHATSAPP:689 45 44 70

# Resistors

- The analysis in the time domain is characterized by the voltage drop  $v(t)$  and by the current passing through the element.  $i(t)$ .
- In a resistor, you only have to apply Ohm's law:

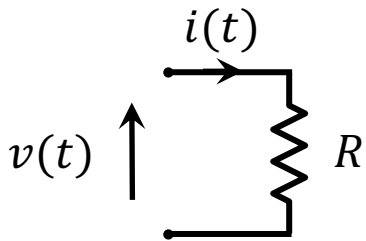

$$\text{if } v(t) = V_m \cos(\omega t + \phi_v) \rightarrow i(t) = \frac{v(t)}{R} = \frac{V_m}{R} \cos(\omega t + \phi_v) \rightarrow$$

$$i(t) = I_m \cos(\omega t + \phi_v)$$

	$v(t)$	$i(t)$
Amplitude	$V_m$	$V_m/R$
Frequency	$\omega$	$\omega$
Phase	$\phi_v$	$\phi_v$

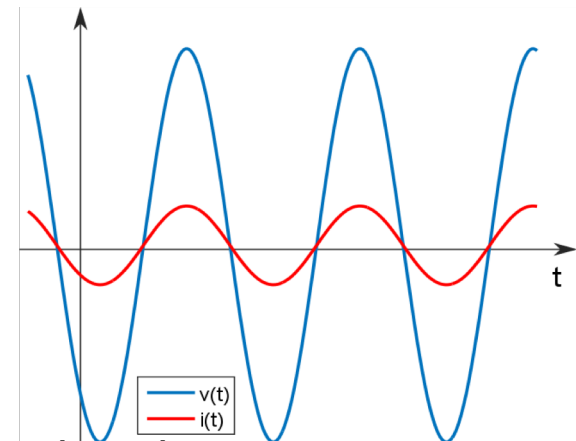

CLASES PARTICULARES, TUTORÍAS TÉCNICAS ONLINE  
 LLAMA O ENVÍA WHATSAPP: 689 45 44 70

---

ONLINE PRIVATE LESSONS FOR SCIENCE STUDENTS  
 CALL OR WHATSAPP: 689 45 44 70

Cartagena99

# Capacitor

- A capacitor is a passive element that is able to store electrical energy.
  - Applications: AC/DC decouple, current fluctuations control, filters, timers, sensors, etc
- It is build of to conductors separated by a dielectric material.
  - The symbol is two thin parallel plates

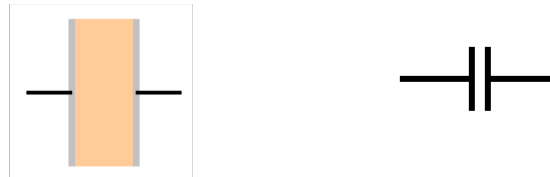

## Real capacitors



CLASES PARTICULARES, TUTORÍAS TÉCNICAS ONLINE  
LLAMA O ENVÍA WHATSAPP: 689 45 44 70

---  
ONLINE PRIVATE LESSONS FOR SCIENCE STUDENTS  
CALL OR WHATSAPP:689 45 44 70

# Capacitors

- It takes some time to fully charge the capacitor. The easiest way is to connect the capacitor to a battery, so that during the charging process:
  - There is a current  $i(t)$  flowing from one plate to the other.
  - This current displaces charges, so that an electric field is created, therefore a voltage appears in the plates  $v(t)$ .
  - The charging process stops when the voltage in the capacitor equals the voltage source, so that the current is zero.
  - When the capacitor is fully charged and the battery is removed both plates have the same charge but with different sign, and the voltage is the same as in the source.
  - The capacitor discharges in a similar way, when it is connected to a load. In a discharged capacitor the plates do not have charge, and the voltage is zero.
- Capacitance is the property that allows capacitors to keep an electric charge, it is defined as the relationship between the charge in the positive plate, ( $q > 0$ ) and the voltage between the plates, ( $v > 0$ ).

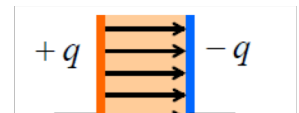
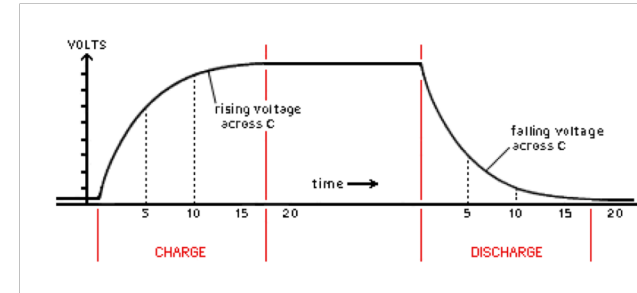

Cartagena99

CLASES PARTICULARES, TUTORÍAS TÉCNICAS ONLINE  
LLAMA O ENVÍA WHATSAPP: 689 45 44 70

---

ONLINE PRIVATE LESSONS FOR SCIENCE STUDENTS  
CALL OR WHATSAPP: 689 45 44 70

# Capacitors

- The relationship between  $v(t)$  and  $i(t)$  in a capacitor is obtained from the expression of the charge and voltage:

$$q = Cv$$

- The rate of charge variation:

$$\frac{dq}{dt} = C \frac{dv}{dt} \rightarrow i(t) = C \frac{dv(t)}{dt}$$

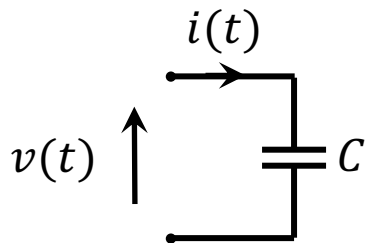

$$\text{If } v(t) = V_m \cos(\omega t + \phi_v) \rightarrow i(t) = C \frac{dv(t)}{dt} = V_m C \omega \sin(\omega t + \phi_v) \rightarrow$$

$$i(t) = V_m C \omega \cos\left(\omega t + \phi_v + \frac{\pi}{2}\right)$$

	$v(t)$	$i(t)$
Amplitude	$V_m$	$V_m C \omega$
Frequency	$\omega$	$\omega$
Phase	$\phi_v$	$\phi_v + \frac{\pi}{2}$

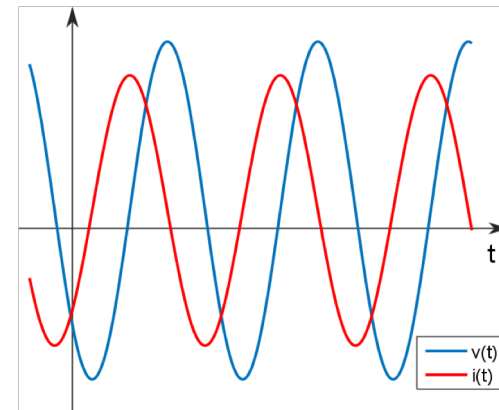

Cartagena99

CLASES PARTICULARES, TUTORÍAS TÉCNICAS ONLINE  
 LLAMA O ENVÍA WHATSAPP: 689 45 44 70

---

ONLINE PRIVATE LESSONS FOR SCIENCE STUDENTS  
 CALL OR WHATSAPP:689 45 44 70

# Capacitors

- To get the voltage from the current in a capacitor we need to solve a simple differential equation:

$$i(t) = C \frac{dv}{dt} \rightarrow dv = \frac{1}{C} i dt \rightarrow \int_{t_0}^t dv = \frac{1}{C} \int_{t_0}^t i dt \rightarrow v(t) = \frac{1}{C} \int_{t_0}^t i dt + v(t_0)$$

- where  $v(t_0)$  is the initial voltage  $t = t_0$

- The capacitor is an element with memory (remember from systems properties that the integrator is a memory systems): the voltage between plates depends on past values of the current and the initial voltage.
- Since the derivative needs the function to be continuous, so that the voltage in a capacitor cannot have discontinuities.

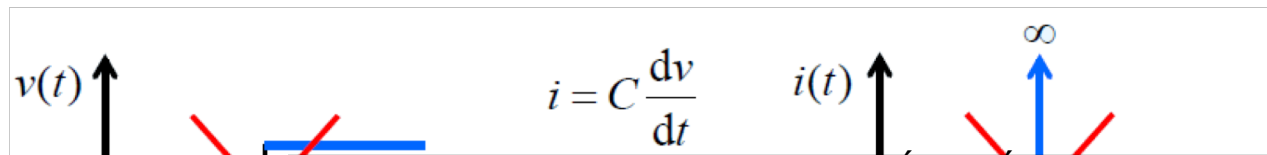

CLASES PARTICULARES, TUTORÍAS TÉCNICAS ONLINE  
LLAMA O ENVÍA WHATSAPP: 689 45 44 70

---

ONLINE PRIVATE LESSONS FOR SCIENCE STUDENTS  
CALL OR WHATSAPP: 689 45 44 70

# Capacitors

- The instantaneous power in a capacitor is computed multiplying voltage and current

$$p(t) = v(t)i(t) = v(t)C \frac{dv(t)}{dt}$$

- The power in a capacitor can be positive (storing energy) or negative, delivering energy.

- The stored energy in a capacitor, can be calculated as:  $p = \frac{dw}{dt} \Rightarrow dw = p dt$

$$\int_{-\infty}^t dw = \int_{-\infty}^t p dt$$

$$w(t) - w(-\infty) = \int_{-\infty}^t p dt = \int_{-\infty}^t C v \frac{dv}{dt} dt = C \int_{-\infty}^t v dv = \frac{1}{2} C v^2 \Big|_{-\infty}^t$$

- Since in  $t=-\infty$  the capacitor is discharged:

$$v(-\infty) = 0 \Rightarrow w(-\infty) = 0$$

- Then:

Cartagena99

CLASES PARTICULARES, TUTORÍAS TÉCNICAS ONLINE  
LLAMA O ENVÍA WHATSAPP: 689 45 44 70

---

ONLINE PRIVATE LESSONS FOR SCIENCE STUDENTS  
CALL OR WHATSAPP:689 45 44 70

# Capacitors

- Parallel interconnection:

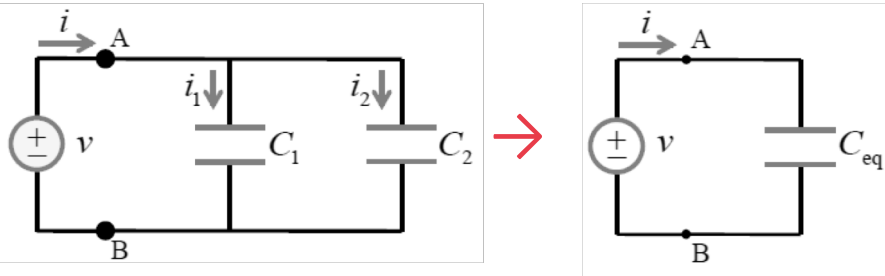

KLC:

$$i = i_1 + i_2 \quad \text{with} \quad i_1 = C_1 \frac{dv}{dt} \quad i_2 = C_2 \frac{dv}{dt}$$

$$i = (C_1 + C_2) \frac{dv}{dt} \quad \rightarrow \quad i = C_{eq} \frac{dv}{dt} \quad \text{where} \quad C_{eq} = C_1 + C_2$$

General:

$$C_{eq} = C_1 + C_2 + \dots + C_N = \sum_{n=1}^N C_n$$

- Series interconnection:

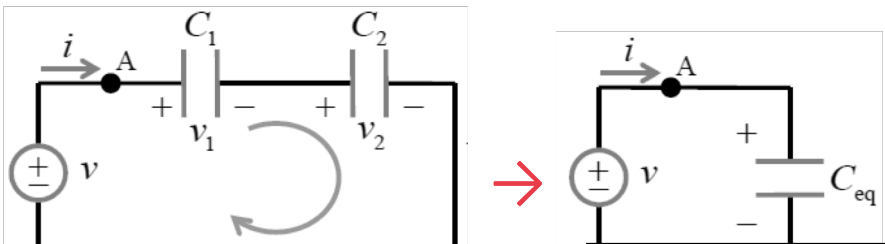

KLV:

$$v = v_1 + v_2 \quad \text{with} \quad v_1 = \frac{1}{C_1} \int_{t_0}^t idt + v_1(t_0) \quad v_2 = \frac{1}{C_2} \int_{t_0}^t idt + v_2(t_0)$$

$$v = \left( \frac{1}{C_1} + \frac{1}{C_2} \right) \int_{t_0}^t idt + v_1(t_0) + v_2(t_0) \quad \rightarrow \quad v = \frac{1}{C_{eq}} \int_{t_0}^t idt + v(t_0)$$

where  $\frac{1}{C_{eq}} = \frac{1}{C_1} + \frac{1}{C_2}$

CLASES PARTICULARES, TUTORÍAS TÉCNICAS ONLINE  
LLAMA O ENVÍA WHATSAPP: 689 45 44 70

---

ONLINE PRIVATE LESSONS FOR SCIENCE STUDENTS  
CALL OR WHATSAPP:689 45 44 70

Cartagena99



# Inductor

- An inductor is a passive element that is able to store magnetic energy:
- The most simple configuration is a straight solenoid with a magnetic material inside (ex.: ferrita).
  - The following symbol is used to identify an inductor in a circuit:

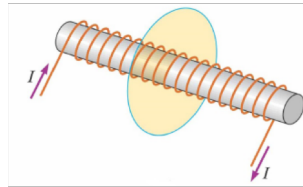

Cartagena99

CLASES PARTICULARES, TUTORÍAS TÉCNICAS ONLINE  
LLAMA O ENVÍA WHATSAPP: 689 45 44 70

---

ONLINE PRIVATE LESSONS FOR SCIENCE STUDENTS  
CALL OR WHATSAPP:689 45 44 70

# Inductors

- When an electric current passes through an inductor, a magnetic field is created, that induce an electromotive force in opposition to the current change
- As a consequences of the magnetic field, the inductor gets charged.
  - The current in the circuit increases up until a maximum constant value.
  - At this point the inductor is equivalent to a shortcircuit.
  - The induced electromotive force is decreasing exponentially at the same rate as the current is increasing.
  - The discharging process is similar, when the inductor is disconnected from the source, there will be a current for a given time whose intensity decreases exponentially, due to the liberation of the magnetic field previously stored. In this process, the voltage in the inductor will increase at the same rate.
- The inductance is a measure of the opposition to a change in the current passing through the inductor in the presence of a magnetic field. It is defined as the relationship between the magnetic flux and the current intensity in the inductor and the number of turns in the winding.
  - Units (H). 1 Henry= 1 Weber/1 Amper.

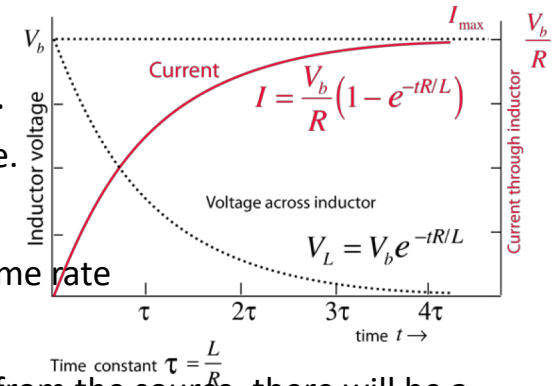

CLASES PARTICULARES, TUTORÍAS TÉCNICAS ONLINE  
LLAMA O ENVÍA WHATSAPP: 689 45 44 70

ONLINE PRIVATE LESSONS FOR SCIENCE STUDENTS  
CALL OR WHATSAPP:689 45 44 70

# Inductors

- The relationship between  $v(t)$  and  $i(t)$  is given by the expression:

$$v = L \frac{di}{dt}$$

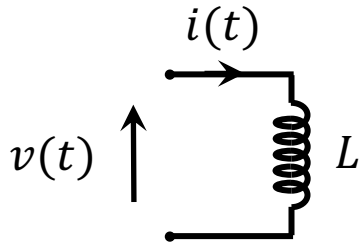

$$\text{If } v(t) = V_m \cos(\omega t + \phi_v) \rightarrow di = \frac{1}{L} v dt \rightarrow \int_{t_0}^t di = \frac{1}{L} \int_{t_0}^t v dt \rightarrow$$

$$i(t) = \frac{1}{L} \int_{t_0}^t v dt + i(t_0)$$

$$i(t) = \frac{V_m}{\omega L} \sin(\omega t + \phi_v) = \frac{V_m}{\omega L} \cos\left(\omega t + \phi_v - \frac{\pi}{2}\right)$$

- The inductor is a memory element, the current that passes through it depends on the past values of the voltage and the initial current

	$v(t)$	$i(t)$
Amplitude	$V_m$	$V_m/\omega L$
Frequency	$\omega$	$\omega$
Phase	$\phi_v$	$\phi_v - \frac{\pi}{2}$

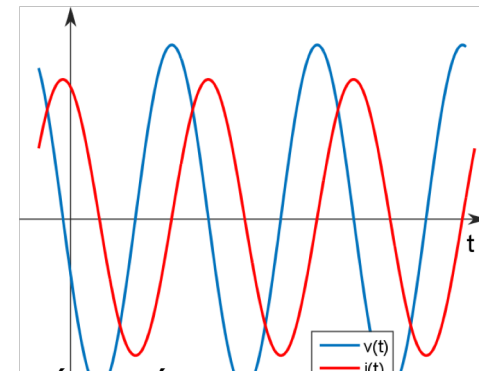

CLASES PARTICULARES, TUTORÍAS TÉCNICAS ONLINE  
 LLAMA O ENVÍA WHATSAPP: 689 45 44 70

---

ONLINE PRIVATE LESSONS FOR SCIENCE STUDENTS  
 CALL OR WHATSAPP: 689 45 44 70

Cartagena99

# Inductors

- To obtain the voltage in terms of the current we need to use the following expression  $v = L \frac{di}{dt}$
- Being  $i$  the expression computed in previous slide

$$i(t) = \frac{V_m}{\omega L} \sin(\omega t + \phi_v) = \frac{V_m}{\omega L} \cos\left(\omega t + \phi_v - \frac{\pi}{2}\right)$$

- Since the derivative needs a continuous functions, then the current in an inductor cannot have discontinuities.

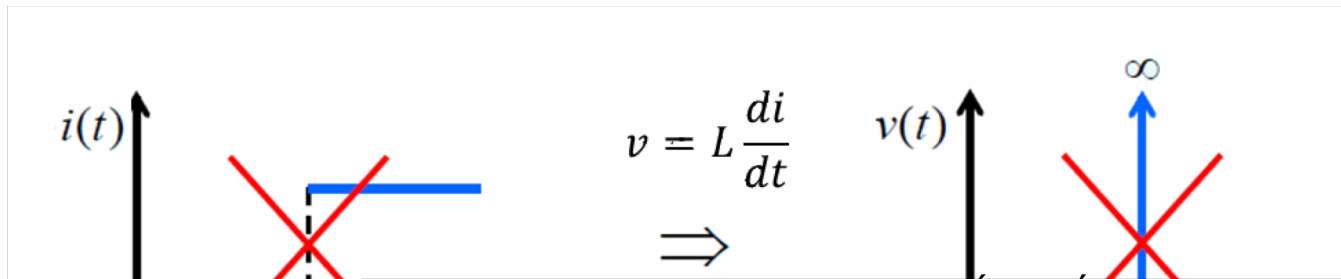

CLASES PARTICULARES, TUTORÍAS TÉCNICAS ONLINE  
LLAMA O ENVÍA WHATSAPP: 689 45 44 70

---

ONLINE PRIVATE LESSONS FOR SCIENCE STUDENTS  
CALL OR WHATSAPP:689 45 44 70

# Inductors

- The instantaneous power in an inductor is computed as:

$$p(t) = v(t)i(t) = Li(t) \frac{di(t)}{dt}$$

- The power can be positive, the inductor stores energy, or negative, the inductor delivers energy.

- The energy stored in an inductor can be computed as:

$$p = \frac{dw}{dt} \Rightarrow dw = p dt$$

$$\int_{-\infty}^t dw = \int_{-\infty}^t p dt$$

$$w(t) - w(-\infty) = \int_{-\infty}^t p dt = \int_{-\infty}^t Li \frac{di}{dt} dt = L \int_{-\infty}^t i di = \frac{1}{2} Li^2 \Big|_{-\infty}^t$$

- Since at  $t=-\infty$  the inductor is discharged:

$$i(-\infty) = 0 \quad \text{y} \quad w(-\infty) = 0$$

- Then:

Cartagena99

CLASES PARTICULARES, TUTORÍAS TÉCNICAS ONLINE  
LLAMA O ENVÍA WHATSAPP: 689 45 44 70

---

ONLINE PRIVATE LESSONS FOR SCIENCE STUDENTS  
CALL OR WHATSAPP: 689 45 44 70

# Inductors

## Interconnection in parallel

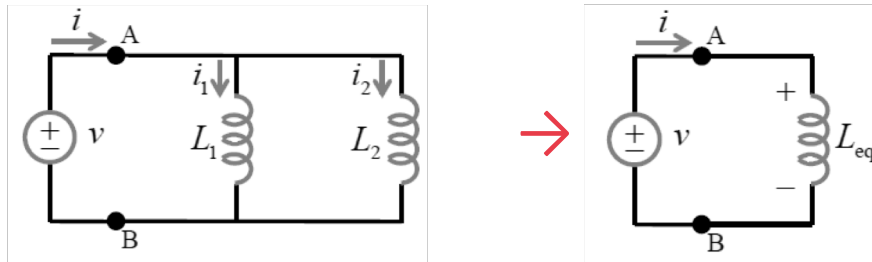

KLC

$$i = i_1 + i_2 \quad \text{with} \quad i_1 = \frac{1}{L_1} \int_{t_0}^t v dt + i_1(t_0); \quad i_2 = \frac{1}{L_2} \int_{t_0}^t v dt + i_2(t_0)$$

$$i = \left( \frac{1}{L_1} + \frac{1}{L_2} \right) \int_{t_0}^t v dt + i(t_0) \quad \Rightarrow \quad i = \frac{1}{L_{eq}} \int_{t_0}^t v dt + i(t_0)$$

where 
$$\frac{1}{L_{eq}} = \frac{1}{L_1} + \frac{1}{L_2}$$

General case: 
$$\frac{1}{L_{eq}} = \frac{1}{L_1} + \frac{1}{L_2} + \dots + \frac{1}{L_N} = \sum_{n=1}^N \frac{1}{L_n}$$

## Interconnection in series

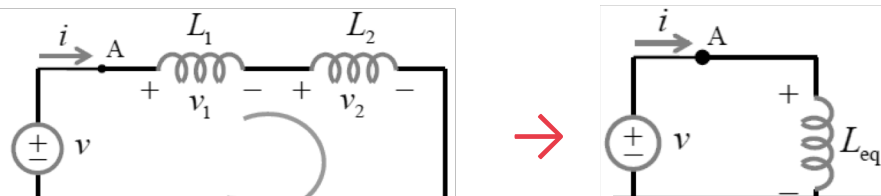

KLV

$$v = v_1 + v_2 \quad \text{with} \quad v_1 = L_1 \frac{di}{dt} \quad v_2 = L_2 \frac{di}{dt}$$

$$v = (L_1 + L_2) \frac{di}{dt} \quad \Rightarrow \quad v = L_{eq} \frac{di}{dt} \quad \text{where} \quad L_{eq} = L_1 + L_2$$

CLASES PARTICULARES, TUTORÍAS TÉCNICAS ONLINE  
LLAMA O ENVÍA WHATSAPP: 689 45 44 70

---

ONLINE PRIVATE LESSONS FOR SCIENCE STUDENTS  
CALL OR WHATSAPP: 689 45 44 70

# Inductors

- **Example 3:** find the stored energy in the capacitor and in the inductor in the left figure in continuous state. (compute voltage and current by using the equivalent in direct current).
- **Example 4:** compute the equivalent inductance from the terminals A and B, right figure.

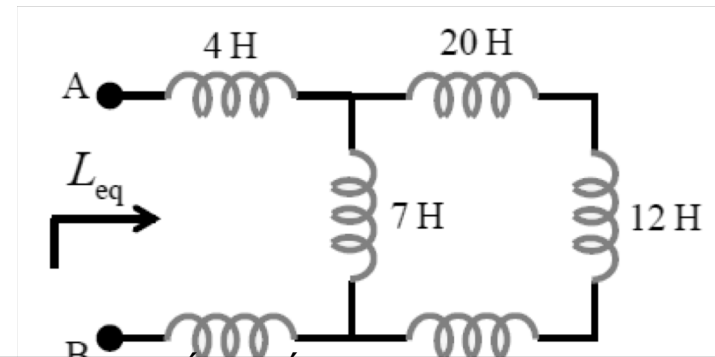
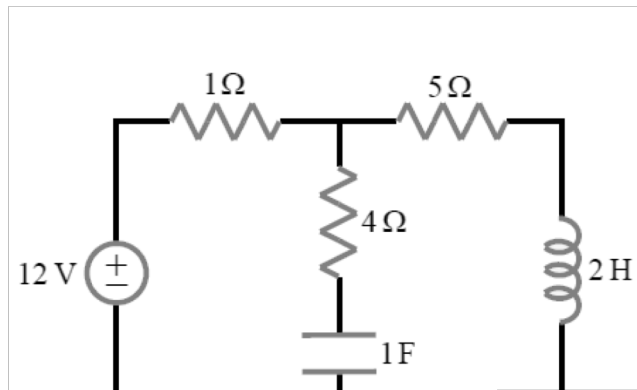

CLASES PARTICULARES, TUTORÍAS TÉCNICAS ONLINE  
LLAMA O ENVÍA WHATSAPP: 689 45 44 70

---

ONLINE PRIVATE LESSONS FOR SCIENCE STUDENTS  
CALL OR WHATSAPP:689 45 44 70

### Important characteristics of the basic elements.†

Relation	Resistor ( $R$ )	Capacitor ( $C$ )	Inductor ( $L$ )
$v-i$ :	$v = iR$	$v = \frac{1}{C} \int_{t_0}^t i dt + v(t_0)$	$v = L \frac{di}{dt}$
$i-v$ :	$i = v/R$	$i = C \frac{dv}{dt}$	$i = \frac{1}{L} \int_{t_0}^t v dt + i(t_0)$
$p$ or $w$ :	$p = i^2 R = \frac{v^2}{R}$	$w = \frac{1}{2} C v^2$	$w = \frac{1}{2} L i^2$
Series:	$R_{eq} = R_1 + R_2$	$C_{eq} = \frac{C_1 C_2}{C_1 + C_2}$	$L_{eq} = L_1 + L_2$
Parallel:	$R_{eq} = \frac{R_1 R_2}{R_1 + R_2}$	$C_{eq} = C_1 + C_2$	$L_{eq} = \frac{L_1 L_2}{L_1 + L_2}$
At dc:	Same	Open circuit	Short circuit
Circuit variable that cannot change abruptly:	Not applicable	$v$	$i$

# Cartagena99

CLASES PARTICULARES, TUTORÍAS TÉCNICAS ONLINE  
 LLAMA O ENVÍA WHATSAPP: 689 45 44 70

---

ONLINE PRIVATE LESSONS FOR SCIENCE STUDENTS  
 CALL OR WHATSAPP: 689 45 44 70





# Sinusoidal Response

Cartagena99

CLASES PARTICULARES, TUTORÍAS TÉCNICAS ONLINE  
LLAMA O ENVIA WHATSAPP: 689 45 44 70

---

ONLINE PRIVATE LESSONS FOR SCIENCE STUDENTS  
CALL OR WHATSAPP:689 45 44 70

# Phasor

Cartagena99

CLASES PARTICULARES, TUTORÍAS TÉCNICAS ONLINE  
LLAMA O ENVIA WHATSAPP: 689 45 44 70

---

ONLINE PRIVATE LESSONS FOR SCIENCE STUDENTS  
CALL OR WHATSAPP:689 45 44 70

# Phasor

- A **Phasor** is a complex number that represents the amplitude and the phase of a sinusoidal signals.

- It allows to analyze easily linear circuits with sinusoidal sources in steady-state.
- The phasor is based on the Euler's identity

$$\cos \theta = \operatorname{Re}[e^{\pm j\theta}] \quad \pm \sin \theta = \operatorname{Im}[e^{\pm j\theta}]$$

$$e^{\pm j\theta} = \cos \theta \pm j \sin \theta$$

- From the signal that is used to define the sources, we can establish:

$$v(t) = V_m \cos(\omega t + \phi) = \operatorname{Re}[V_m e^{j(\omega t + \phi)}]$$

- So that, we can express briefly, the previous signals as:

$$v(t) = \operatorname{Re}[V_m e^{j\phi} e^{j\omega t}] \quad v(t) = \operatorname{Re}[V e^{j\omega t}]$$

- So that, V is the phasor representation of the sinusoidal signal v(t).

$$V = V_m e^{j\phi}$$

$$V = V_m \angle \phi$$

- A phasor is a complex representations of the magnitude and phase of a sinusoidal signal with a given a frequency

CLASES PARTICULARES, TUTORIAS TECNICAS ONLINE  
 LLAMA O ENVIA WHATSAPP: 689 45 44 70

---

ONLINE PRIVATE LESSONS FOR SCIENCE STUDENTS  
 CALL OR WHATSAPP:689 45 44 70

Cartagena99

# Phasor

- So, there are two equivalent forms to represent a sinusoidal signal analytically:



- If  $V$  (o  $\mathbb{V}$ ) is known,  $v(t)$  can be obtained:  $v(t) = \text{Re}[V e^{j\omega t}]$
- If  $v(t)$  is known,  $V$  can be obtained:  $V = V_m e^{j\phi}$

- It is possible to obtain a graphical representation in the phasorial domain using the complex plane:

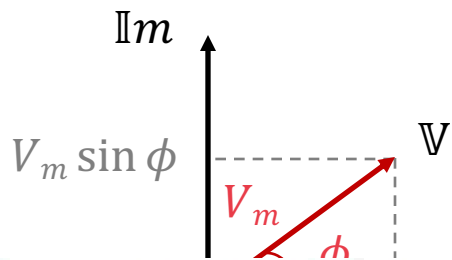

Adding temporal variation:

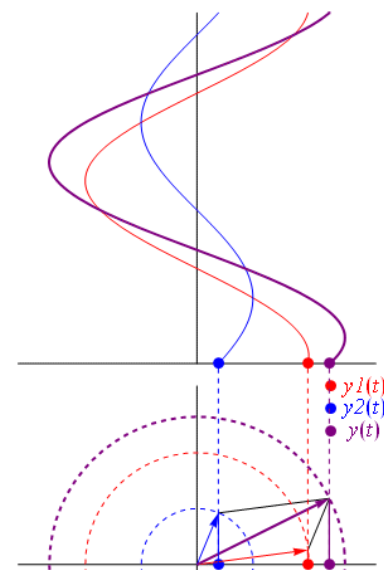

CLASES PARTICULARES, TUTORÍAS TÉCNICAS ONLINE  
 LLAMA O ENVÍA WHATSAPP: 689 45 44 70

---

ONLINE PRIVATE LESSONS FOR SCIENCE STUDENTS  
 CALL OR WHATSAPP: 689 45 44 70

Cartagena99

# Phasor

- **Example 5.** Find the Phasor Transform for each of the following sinusoidal signals
  - $v(t) = -4 \sin(30t + 50^\circ)$
  - $i(t) = 6 \cos(50t - 40^\circ)$
  
- **Example 6.** Sketch the following phasors in the complex plane and find the time domain expression:
  - $V = j8e^{-j20^\circ} \text{V}$
  - $I = -3 + j4 \text{ a}$
  
- **Example 7.** Express the sum of the following sinusoidal signals using a) trigonometric identities and b) phasor transforms:
  - $y_1 = 20 \cos(\omega t - 30^\circ)$
  - $y_2 = 40 \cos(\omega t + 60^\circ)$

Cartagena99

CLASES PARTICULARES, TUTORÍAS TÉCNICAS ONLINE  
LLAMA O ENVÍA WHATSAPP: 689 45 44 70

---

ONLINE PRIVATE LESSONS FOR SCIENCE STUDENTS  
CALL OR WHATSAPP: 689 45 44 70

# Impedance and Admittance

Cartagena99

CLASES PARTICULARES, TUTORÍAS TÉCNICAS ONLINE  
LLAMA O ENVIA WHATSAPP: 689 45 44 70

---

ONLINE PRIVATE LESSONS FOR SCIENCE STUDENTS  
CALL OR WHATSAPP:689 45 44 70

# Impedance

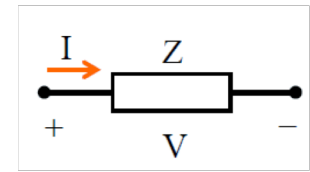

- The **impedance** ( $Z$ ) of a circuit element is defined as the ratio of a voltage and its current pashors:

$$Z = \frac{V}{I} \quad [\Omega]$$

- In AC circuits the impedance plays an role analogous to that of the resistance in DC circuits, with some nuances
- The impedance is a complex function of the frequency (it depends on  $\omega$ )
- In general general, the impedance can be expressed as:

$$Z = R + jX \quad (R \text{ and } X \text{ reals})$$

- The real part is called Resistance ( $R$ )
- The imaginary part Reactance ( $X$ )
  - If  $X > 0$  inductive reactance.
  - If  $X < 0$  capacitive reactance.

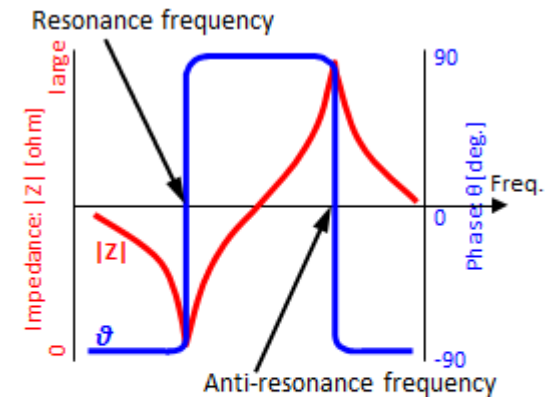

CLASES PARTICULARES, TUTORÍAS TÉCNICAS ONLINE  
 LLAMA O ENVÍA WHATSAPP: 689 45 44 70

ONLINE PRIVATE LESSONS FOR SCIENCE STUDENTS  
 CALL OR WHATSAPP:689 45 44 70

Cartagena99

# Admittance

- In some situations, it is useful to work with the inverse of the, called admittance  $Y$ :

$$Y = \frac{1}{Z} \quad [S]$$

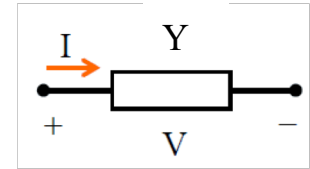

- The admittance is a complex function of the frequency
- In general, the admittance can be expressed as:

$$Y = G + jB \quad (G \text{ y } B \text{ are reals})$$

- The real part of the admittance is called Conductance ( $G$ )
- The imaginary part of the admittance is called Susceptance ( $B$ )

Cartagena99

CLASES PARTICULARES, TUTORÍAS TÉCNICAS ONLINE  
LLAMA O ENVÍA WHATSAPP: 689 45 44 70

---

ONLINE PRIVATE LESSONS FOR SCIENCE STUDENTS  
CALL OR WHATSAPP:689 45 44 70



# Phasor relationship for R, L y C

Cartagena99

CLASES PARTICULARES, TUTORÍAS TÉCNICAS ONLINE  
LLAMA O ENVÍA WHATSAPP: 689 45 44 70

---

ONLINE PRIVATE LESSONS FOR SCIENCE STUDENTS  
CALL OR WHATSAPP:689 45 44 70

# Phasor relationship for a Resistor

- Relationship between phasor current and phasor voltage at the terminals of a resistor

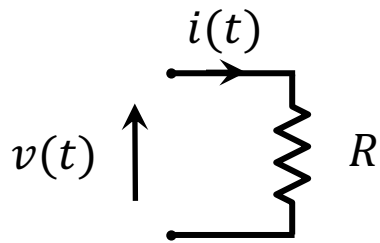

Time domain

$$v(t) = V_m \cos(\omega t + \phi_v) \quad e \quad i(t) = \frac{v(t)}{R} = \frac{V_m}{R} \cos(\omega t + \phi_v)$$

Phasor domain

$$V = V_m e^{j\phi_v} \quad e \quad I = \frac{V_m}{R} e^{j\phi_v} \quad \longrightarrow \quad Z = \frac{V}{I} = R$$

Phasor Diagram

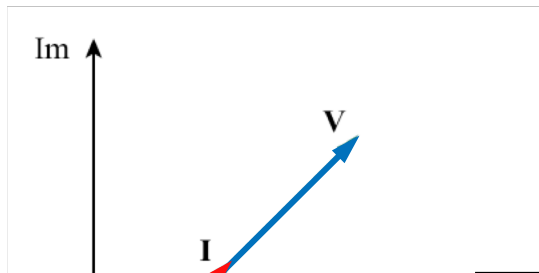

Instantaneous signals

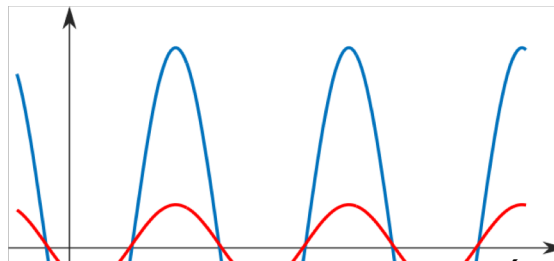

In a resistor the current and the voltage are in phase

CLASES PARTICULARES, TUTORÍAS TÉCNICAS ONLINE  
LLAMA O ENVÍA WHATSAPP: 689 45 44 70

---

ONLINE PRIVATE LESSONS FOR SCIENCE STUDENTS  
CALL OR WHATSAPP: 689 45 44 70

# Phasor relationship for an Inductor

- Relationship between phasor current and phasor voltage at the terminals of an inductor

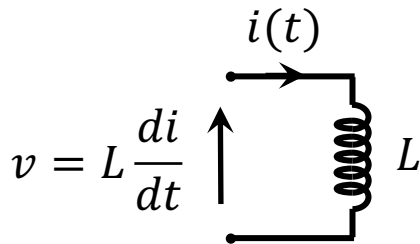

Time domain

$$v(t) = V_m \cos(\omega t + \phi_v) \quad e \quad i(t) = \frac{V_m}{\omega L} \cos\left(\omega t + \phi_v - \frac{\pi}{2}\right)$$

Phasor domain

$$V = V_m e^{j\phi_v} \quad e \quad I = \frac{V_m}{\omega L} e^{j\phi_v - \frac{\pi}{2}} \quad \rightarrow \quad Z = \frac{V}{I} = \omega L e^{j\frac{\pi}{2}} = j\omega L$$

Phasor Diagram

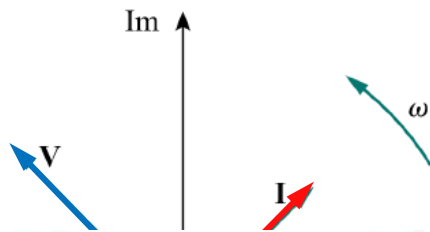

Instantaneous signals

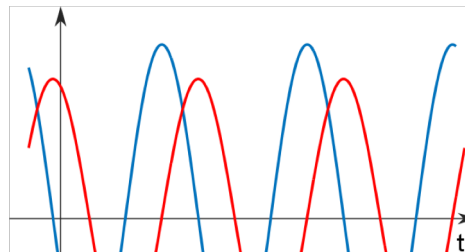

Voltage and current are out of phase by exactly  $\pi/2$ . In

CLASES PARTICULARES, TUTORÍAS TÉCNICAS ONLINE  
LLAMA O ENVÍA WHATSAPP: 689 45 44 70

---

ONLINE PRIVATE LESSONS FOR SCIENCE STUDENTS  
CALL OR WHATSAPP: 689 45 44 70

# Phasor relationship for a Capacitor

- Relationship between phasor current and phasor voltage at the terminals of a capacitor

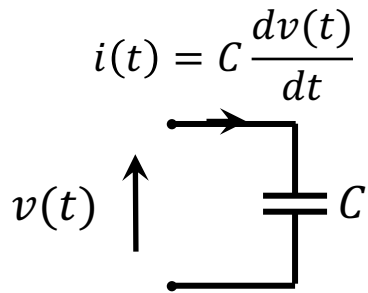

Time domain

$$v(t) = V_m \cos(\omega t + \phi_v) \quad e \quad i(t) = V_m C \omega \cos\left(\omega t + \phi_v + \frac{\pi}{2}\right)$$

Phasor domain

$$V = V_m e^{j\phi_v} \quad e \quad I = V_m C \omega e^{j\phi_v + \frac{\pi}{2}} \rightarrow Z = \frac{V}{I} = \frac{1}{\omega C e^{j\frac{\pi}{2}}} = \frac{1}{j\omega C}$$

Phasor Diagrama

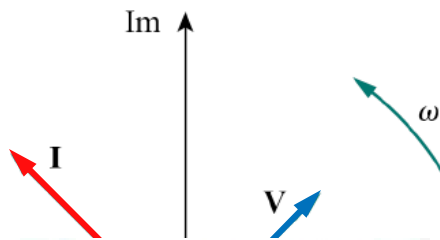

Instantaneous signals

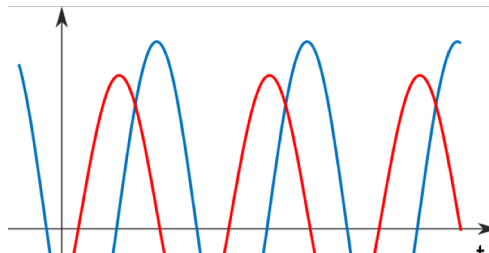

The voltage across the terminals of a capacitor lags behind

CLASES PARTICULARES, TUTORÍAS TÉCNICAS ONLINE  
LLAMA O ENVIA WHATSAPP: 689 45 44 70

---

ONLINE PRIVATE LESSONS FOR SCIENCE STUDENTS  
CALL OR WHATSAPP: 689 45 44 70

# Phasor Relationship for R, L and C

Impedances and admittances of passive elements.

Element	Impedance	Admittance
$R$	$Z = R$	$Y = \frac{1}{R}$
$L$	$Z = j\omega L$	$Y = \frac{1}{j\omega L}$
$C$	$Z = \frac{1}{j\omega C}$	$Y = j\omega C$

Resistencia

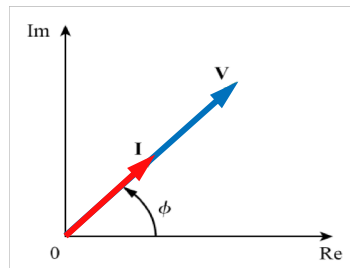

Bobina

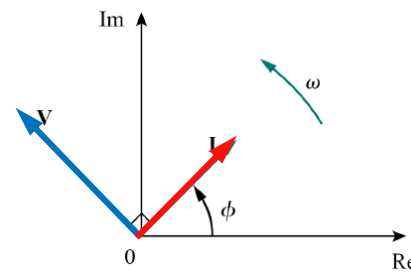

Condensador

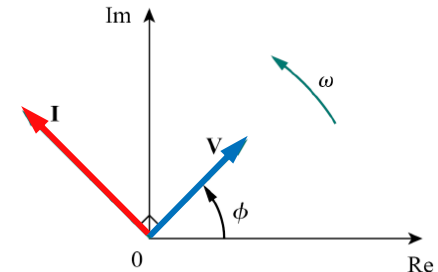

- Example 8.** A current  $i(t) = 10 \cos(10000t + 30^\circ) \text{ mA}$  passes through and inductor with inductance 20 mH. Find:
  - The reactance.
  - The impedance

Cartagena99

CLASES PARTICULARES, TUTORÍAS TÉCNICAS ONLINE  
 LLAMA O ENVÍA WHATSAPP: 689 45 44 70

ONLINE PRIVATE LESSONS FOR SCIENCE STUDENTS  
 CALL OR WHATSAPP:689 45 44 70

# Sinusoidal Steady-State Circuit Analysis

Cartagena99

CLASES PARTICULARES, TUTORÍAS TÉCNICAS ONLINE  
LLAMA O ENVIA WHATSAPP: 689 45 44 70

---

ONLINE PRIVATE LESSONS FOR SCIENCE STUDENTS  
CALL OR WHATSAPP:689 45 44 70

# Kirchhoff's Law in Frequency Domain

- The Kirchhoff's laws are valid in the phasor domain, just by extend its formulation

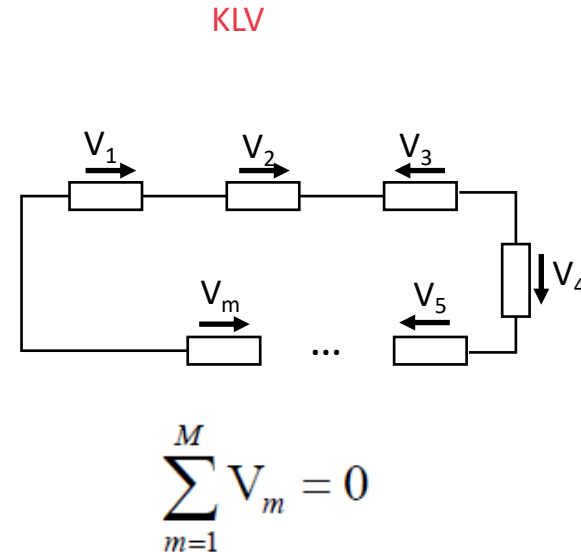
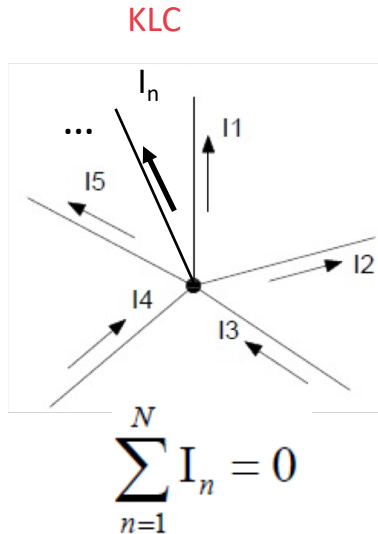

- Therefore, every technique and simplification from topics 4 and 5 applied directly to SSS circuits applying phasors

Cartagena99

CLASES PARTICULARES, TUTORÍAS TÉCNICAS ONLINE  
LLAMA O ENVÍA WHATSAPP: 689 45 44 70

---

ONLINE PRIVATE LESSONS FOR SCIENCE STUDENTS  
CALL OR WHATSAPP:689 45 44 70

# Kirchhoff's Law in Frequency Domain

## Example 9. RL circuit analysis in phasor domain

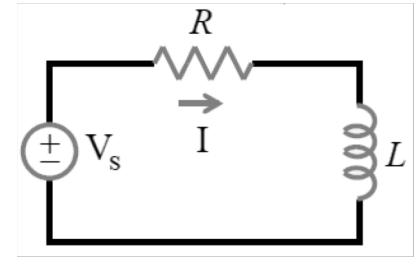

- The voltage source has an expression  $v_s(t) = V_m \cos(\omega t)$
- So that, the phasor is  $V_s = V_m e^{j0}$
- We should calculate the impedances for the elements in the circuit:  $Z_R = R$  and  $Z_L = j\omega L$
- To solve the circuit, we just apply the KLV in the mesh and solve for I, which is the unknown

$$V_s = Z_R I + Z_L I \longrightarrow I = \frac{V_m}{R + j\omega L} = \frac{V_m}{|Z|} e^{j\beta} \quad \text{or} \quad I = \frac{V_m}{|Z|} e^{j\phi_0} \quad \text{with} \quad \phi_0 = -\beta$$

- Where the module and the argument of Z, the equivalent impedance, are defined as:

$$|Z| = \sqrt{R^2 + \omega^2 L^2} \quad \beta = \tan^{-1}(\omega L / R)$$

- The time domain expression of the current is, without solving the differential equation:

CLASES PARTICULARES, TUTORÍAS TÉCNICAS ONLINE  
LLAMA O ENVÍA WHATSAPP: 689 45 44 70

---

ONLINE PRIVATE LESSONS FOR SCIENCE STUDENTS  
CALL OR WHATSAPP: 689 45 44 70

Cartagena99



# Combining impedances in series and parallel

- Just as any circuit element, impedances can be combined in different arrangements:

- Impedances in series:

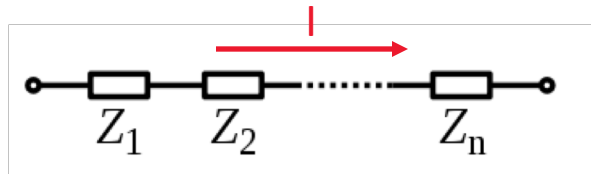

$$Z_{eq} = Z_1 + Z_2 + \dots + Z_n$$

$$Z_{eq} = R + jX = (R_1 + R_2 + \dots + R_n) + j(X_1 + X_2 + \dots + X_n)$$

- Impedances in parallel:

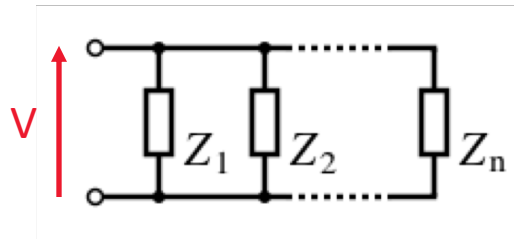

$$\frac{1}{Z_{eq}} = \frac{1}{Z_1} + \frac{1}{Z_2} + \dots + \frac{1}{Z_n}$$

$$Y_{eq} = Y_1 + Y_2 + \dots + Y_N = \sum_{n=1}^N Y_n$$

$$Z_{eq} = R_{eq} + jX_{eq}$$

- If we have two impedances in parallel:

$$\frac{1}{Z_{eq}} = \frac{1}{Z_1} + \frac{1}{Z_2} = \frac{(X_1 R_2 + X_2 R_1)(X_1 + X_2) + (R_1 R_2 - X_1 X_2)(R_1 + R_2)}{(Z_1 Z_2)}$$

CLASES PARTICULARES, TUTORIAS TECNICAS ONLINE  
 LLAMA O ENVIA WHATSAPP: 689 45 44 70

ONLINE PRIVATE LESSONS FOR SCIENCE STUDENTS  
 CALL OR WHATSAPP:689 45 44 70



# Current and Voltage sources transformation

- Sources transformation:

$$V_g = Z I_g$$

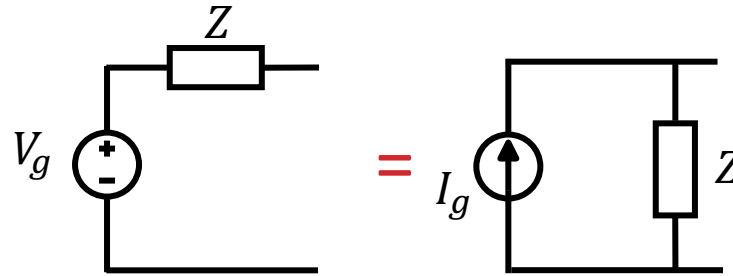

- Voltage divider:

$$v_j = i Z_j = \frac{Z_j}{Z_{eq}} v$$

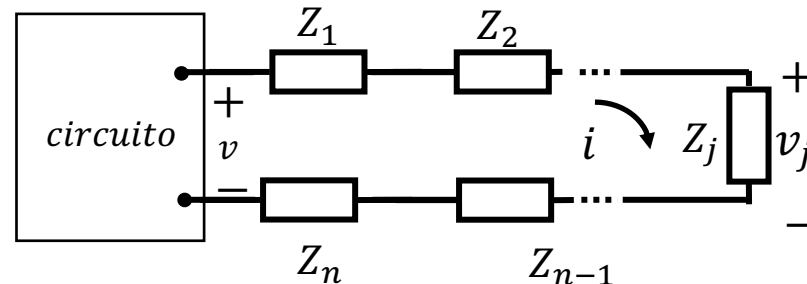

- Current divider:

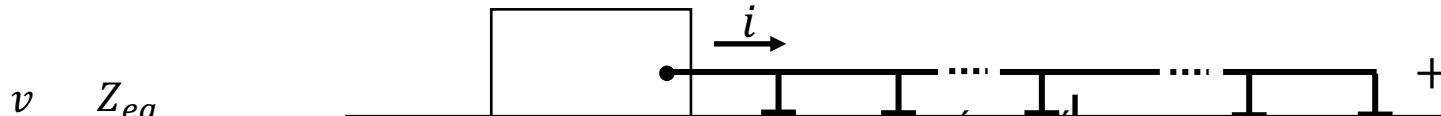

CLASES PARTICULARES, TUTORÍAS TÉCNICAS ONLINE  
 LLAMA O ENVÍA WHATSAPP: 689 45 44 70

ONLINE PRIVATE LESSONS FOR SCIENCE STUDENTS  
 CALL OR WHATSAPP: 689 45 44 70

Cartagena99

# SSS circuit analysis

- **Example 10.** Find the input impedance in the circuit, for an angular frequency of 50 rad/s.

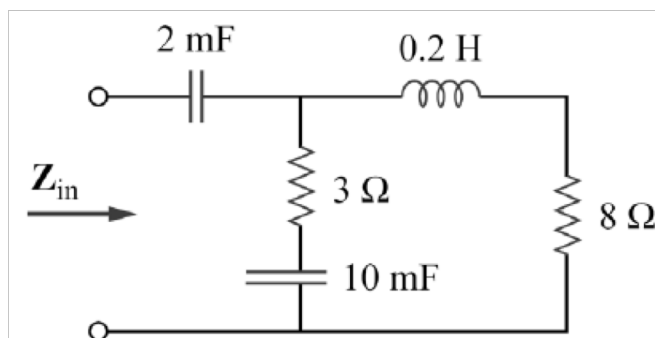

- **Example 11.** Find the expression  $v_o(t)$  in the following circuit.

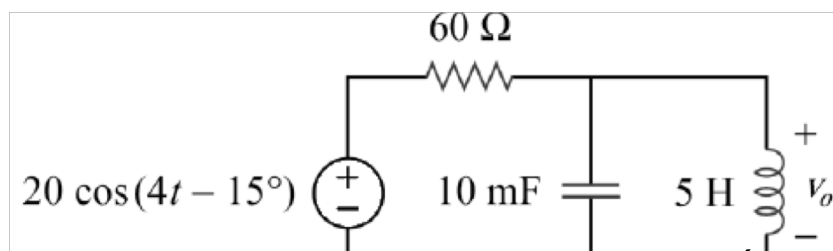

CLASES PARTICULARES, TUTORÍAS TÉCNICAS ONLINE  
LLAMA O ENVÍA WHATSAPP: 689 45 44 70

---

ONLINE PRIVATE LESSONS FOR SCIENCE STUDENTS  
CALL OR WHATSAPP:689 45 44 70

# Node-Voltage and Mesh-Current methods

- The node-voltage and mesh-current techniques from the previous topic, can be applied in an analogous way
- We can distinguish two cases:
  - Case 1: circuit with one or more sources working at the same frequency
    - The circuit is transform into the phasor domain.
    - The circuit is solved applying the techniques studied in previous topics.
    - The circuit is transformed back to the time domain.
  - Case 2: circuit with sources working at different frequencies (***principle of superposition***)
    - Select the sources working at one frequency, and disable the remaining.
    - Solve the circuit using ***case 1***.
    - Repeat the process for the different frequencies in the circuit.

Cartagena99

CLASES PARTICULARES, TUTORÍAS TÉCNICAS ONLINE  
LLAMA O ENVIA WHATSAPP: 689 45 44 70

---

ONLINE PRIVATE LESSONS FOR SCIENCE STUDENTS  
CALL OR WHATSAPP:689 45 44 70

# Node-Voltage and Mesh-Current methods

- **Example 12.** Find  $i_x$  using the node-voltage method.

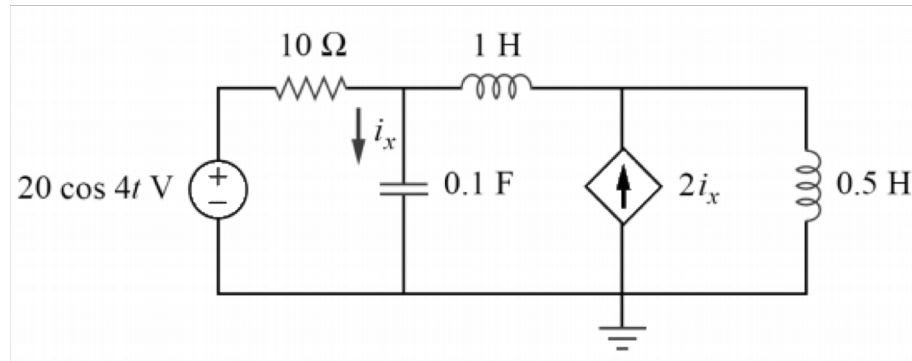

- **Example 13.** Find  $I_0$  using mesh-current method

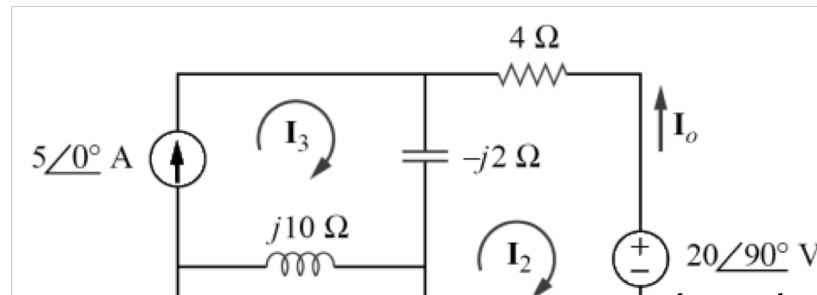

CLASES PARTICULARES, TUTORÍAS TÉCNICAS ONLINE  
LLAMA O ENVÍA WHATSAPP: 689 45 44 70

---

ONLINE PRIVATE LESSONS FOR SCIENCE STUDENTS  
CALL OR WHATSAPP:689 45 44 70

Cartagena99

# Thèvenin and Norton equivalents in sinusoidal steady-state

Cartagena99

CLASES PARTICULARES, TUTORÍAS TÉCNICAS ONLINE  
LLAMA O ENVIA WHATSAPP: 689 45 44 70

---

ONLINE PRIVATE LESSONS FOR SCIENCE STUDENTS  
CALL OR WHATSAPP:689 45 44 70

# Thèvenin y Norton equivalentes

- Thèvenin y Norton equivalentes are computed just using the techniques from the previous topics, but in the phasor domain:

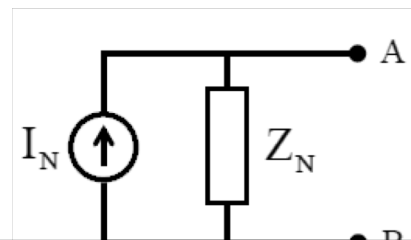
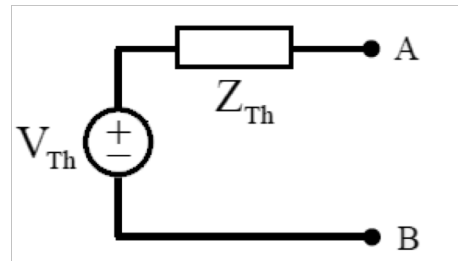
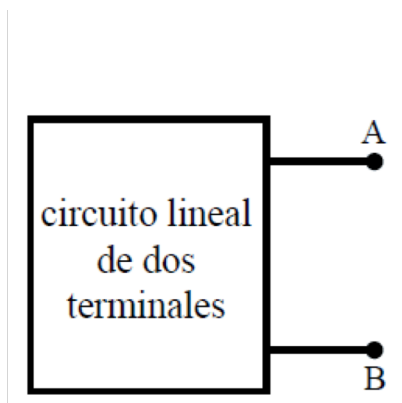

$$V_{Th} = Z_{Th} I_N$$
$$Z_N = Z_{Th}$$

Cartagena99

CLASES PARTICULARES, TUTORÍAS TÉCNICAS ONLINE  
LLAMA O ENVÍA WHATSAPP: 689 45 44 70

---

ONLINE PRIVATE LESSONS FOR SCIENCE STUDENTS  
CALL OR WHATSAPP:689 45 44 70

# Thèvenin y Norton equivalentes

- **Example 14.** Find  $v_o(t)$  when  $v_{g1}(t) = 10 \cos(t - 45^\circ)$  and  $v_{g2}(t) = 5 \text{ sen}(t + 30^\circ)$ .

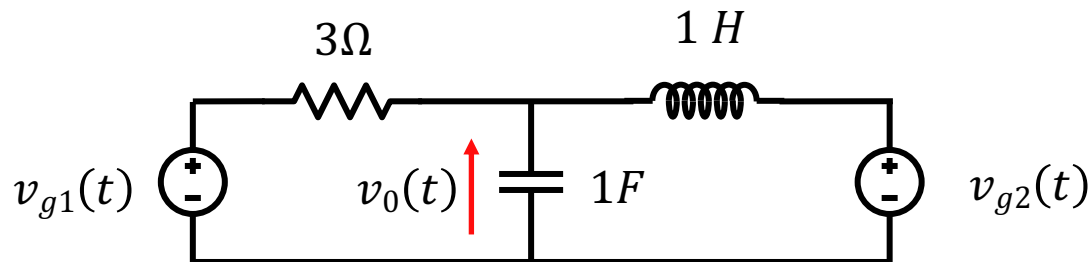

- **Example 15.** Find the Thèvenin equivalent with respect to terminals  $a$  and  $b$ .

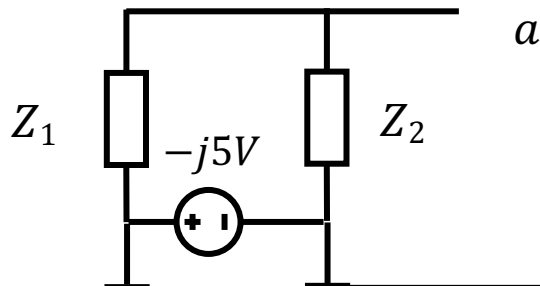

$$Z_1 = 8\Omega$$

$$Z_2 = j10\Omega$$

$$Z_3 = -j2.4\Omega$$

$$Z_4 = j20\Omega$$

CLASES PARTICULARES, TUTORÍAS TÉCNICAS ONLINE  
 LLAMA O ENVÍA WHATSAPP: 689 45 44 70

---

ONLINE PRIVATE LESSONS FOR SCIENCE STUDENTS  
 CALL OR WHATSAPP: 689 45 44 70

Cartagena99



# Power in Sinusoidal Steady-State

Cartagena99

CLASES PARTICULARES, TUTORÍAS TÉCNICAS ONLINE  
LLAMA O ENVIA WHATSAPP: 689 45 44 70

---

ONLINE PRIVATE LESSONS FOR SCIENCE STUDENTS  
CALL OR WHATSAPP:689 45 44 70

# Instantaneous Power

- The instantaneous power  $p(t)$  represents the power for any particular time  $t$ .
- We start with the SSS circuit, where voltage and current are modeled as:

$$v(t) = V_m \cos(\omega t + \phi_v)$$

$$i(t) = I_m \cos(\omega t + \phi_i)$$

e

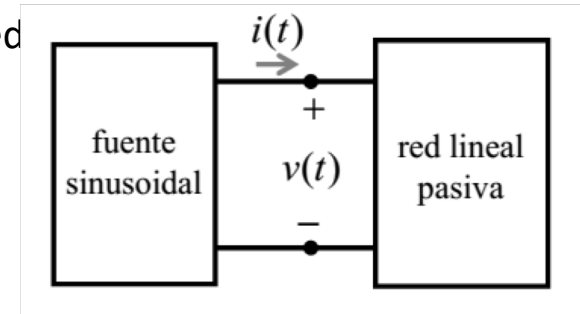

- The instantaneous power can be computed as

$$p(t) = v(t)i(t) = V_m I_m \cos(\omega t + \phi_v) \cos(\omega t + \phi_i) = \underbrace{\frac{1}{2} V_m I_m \cos(\phi_v - \phi_i)}_{Cte} + \underbrace{\frac{1}{2} V_m I_m \cos(2\omega t + \phi_v + \phi_i)}_{f(t)}$$

- The constant term depends on the phase difference
- The time variant term has frequency  $2\omega$

- When  $p(t) > 0$  the circuit absorbs power

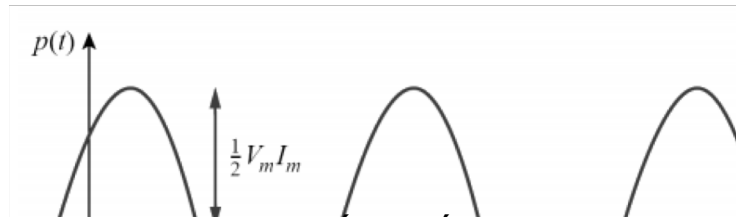

Cartagena99

CLASES PARTICULARES, TUTORÍAS TÉCNICAS ONLINE  
LLAMA O ENVÍA WHATSAPP: 689 45 44 70

---

ONLINE PRIVATE LESSONS FOR SCIENCE STUDENTS  
CALL OR WHATSAPP:689 45 44 70

# Average power

- The instantaneous power  $p(t)$  changes with time, so it is not easy to assess.
- The average power  $P$  is defined as the average of the instantaneous power in one period

$$P = \frac{1}{T} \int_0^T p(t) dt$$

- Using the previous calculated value of the instantaneous power

$$P = \frac{1}{T} \int_0^T \frac{1}{2} V_m I_m \cos(\phi_v - \phi_i) dt + \frac{1}{T} \int_0^T \frac{1}{2} V_m I_m \cos(2\omega t + \phi_v + \phi_i) dt = \frac{1}{2} V_m I_m \cos(\phi_v - \phi_i)$$

- Using current and voltage phasors

$$\mathbf{V} = V_m e^{j\phi_v}$$

$$\mathbf{I} = I_m e^{j\phi_i}$$

- We obtain:

$$\frac{1}{2} \mathbf{V} \mathbf{I}^* = \frac{1}{2} V e^{j\phi_v} I e^{-j\phi_i} = \frac{1}{2} V I e^{j(\phi_v - \phi_i)} = \frac{1}{2} V I [\cos(\phi_v - \phi_i) + j \sin(\phi_v - \phi_i)]$$

Cartagena99

CLASES PARTICULARES, TUTORIAS TÉCNICAS ONLINE  
LLAMA O ENVÍA WHATSAPP: 689 45 44 70

---

ONLINE PRIVATE LESSONS FOR SCIENCE STUDENTS  
CALL OR WHATSAPP: 689 45 44 70

# Average power

- It is worth to note two different cases
  - Average power in a purely resistive circuit (the voltage and current are in phase):

$$P = \frac{1}{2} V_m I_m \cos(\phi_v - \phi_i) = \frac{1}{2} V_m I_m = \frac{1}{2} I_m^2 R = \frac{1}{2} |I|^2 R \geq 0$$

- In a resistive circuit, there is always consumption of energy, so that the average power is always positive.
- The average power in a purely reactive circuit (capacitive or inductive, the voltage and the current have a phase shift of  $\pi/2$ ):

$$P = \frac{1}{2} V_m I_m \cos(\phi_v - \phi_i) = \frac{1}{2} V_m I_m \cos(\pm \frac{\pi}{2}) = 0$$

- In a purely reactive circuit, there is no absorption of energy, the average power is always

Cartagena99

CLASES PARTICULARES, TUTORIAS TECNICAS ONLINE  
LLAMA O ENVIA WHATSAPP: 689 45 44 70

---

ONLINE PRIVATE LESSONS FOR SCIENCE STUDENTS  
CALL OR WHATSAPP: 689 45 44 70

# Maximum power transfer theorem

- In steady conditions of the source, if we have a Thèvenin equivalent with a variable load, the maximum average power transfer to the load is obtained when the load impedance is equal to the complex conjugate of the Thèvenin impedance  $Z_L = Z_{th}^*$
- The current in the circuit can be obtained using Ohm's Law

$$I = \frac{V_{Th}}{Z_{Th} + Z_L}$$

- The average power can be obtained as

$$P = \frac{1}{2} |I|^2 R_L = \frac{|V_{Th}|^2 R_L / 2}{(R_{Th} + R_L)^2 + (X_{Th} + X_L)^2}$$

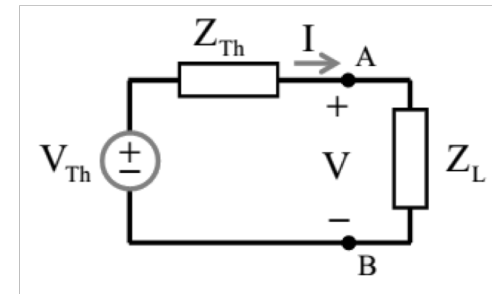

- The only variable element in the circuit is the load impedance
  - We take derivaties (real and imaginary part) :

$$\frac{\partial P}{\partial X_L} = 0 \Rightarrow X_L = -X_{Th}$$

$$\frac{\partial P}{\partial R_L} = 0 \Rightarrow R_L = \sqrt{R_{Th}^2 + (X_{Th} + X_L)^2} = R_{Th}$$

$$X_L = -X_{Th}$$



$$Z_L = Z_{Th}^*$$

Cartagena99

CLASES PARTICULARES, TUTORIAS TÉCNICAS ONLINE  
 LLAMA O ENVIA WHATSAPP: 689 45 44 70  
 ---  
 ONLINE PRIVATE LESSONS FOR SCIENCE STUDENTS  
 CALL OR WHATSAPP:689 45 44 70

# Power in SSS

- **Example 16.** Find the average power in the source and in the passive elements:

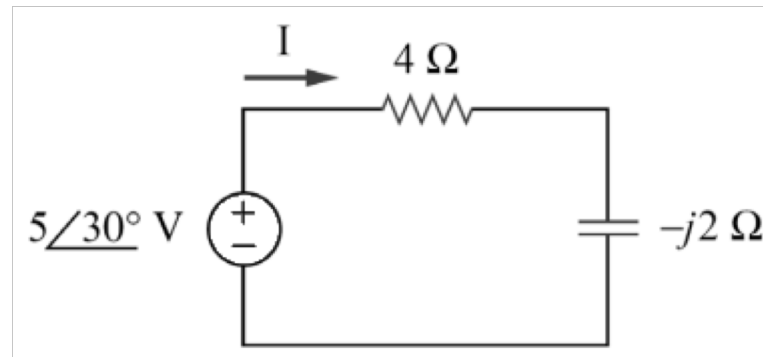

- **Example 17.** Find the load impedance  $Z_l$  that maximize the average absorbed power and compute this power.

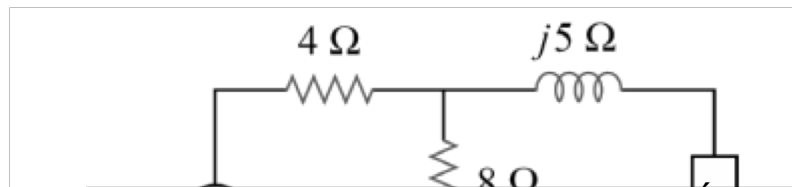

CLASES PARTICULARES, TUTORÍAS TÉCNICAS ONLINE  
LLAMA O ENVÍA WHATSAPP: 689 45 44 70

---

ONLINE PRIVATE LESSONS FOR SCIENCE STUDENTS  
CALL OR WHATSAPP:689 45 44 70

Cartagena99