



Aspen Engineering Suite 2004.1

Aspen Plus 2004.1

Getting Started Modeling Processes with Solids

CLASES PARTICULARES, TUTORÍAS TÉCNICAS ONLINE
LLAMA O ENVÍA WHATSAPP: 689 45 44 70

- - -

ONLINE PRIVATE LESSONS FOR SCIENCE STUDENTS
CALL OR WHATSAPP:689 45 44 70



driving virtual profitability

Who Should Read this Guide

This guide is suitable for Aspen Plus users who want to model processes containing solids. Users should be familiar with the procedures covered in *Aspen Plus Getting Started Building and Running a Process Model* before starting these examples.

CLASES PARTICULARES, TUTORÍAS TÉCNICAS ONLINE
LLAMA O ENVÍA WHATSAPP: 689 45 44 70

- - -

ONLINE PRIVATE LESSONS FOR SCIENCE STUDENTS
CALL OR WHATSAPP:689 45 44 70

Contents

INTRODUCING ASPEN PLUS	7
Why Use Solids Simulation?	8
Sessions in this Book	8
Using Backup Files	8
1 MODELING COAL DRYING.....	9
Coal Drying Flowsheet	10
To Start Aspen Plus	10
To Specify the Application Type and Run Type for the New Run	11
Drawing the Graphical Simulation Flowsheet	11
Stream Classes and Substreams	13
Specifying Title, Stream Properties, and Global Options	13
To Review the Report Options Specified in the Selected Template	14
Specifying Components.....	15
Defining Properties.....	16
Specifying Nonconventional Solid Physical Property Models	17
For More Information on the HCOALGEN Model.....	18
Entering Stream Data	19
Specifying the Nitrogen Stream.....	19
Specifying the Wet Coal Feed Stream.....	20
Specifying Blocks	23
Specifying the Flash2 Block	23
Specifying the RStoic Block.....	24
To Enter the Reaction Stoichiometry	24
Updating the Moisture Content.....	25
Using a Calculator Block to Control Drying	26
Creating the H2OIN Variable.....	27
Creating the Other Variable.....	28
Calculating the Coal Moisture Content.....	28
Specifying When to Calculate.....	29
Running the Simulation	30
Examining Simulation Results	31
To View the Stream Properties.....	31

**CLASES PARTICULARES, TUTORÍAS TÉCNICAS ONLINE
LLAMA O ENVÍA WHATSAPP: 689 45 44 70**

**ONLINE PRIVATE LESSONS FOR SCIENCE STUDENTS
CALL OR WHATSAPP:689 45 44 70**

To View the Block Results.....	34
Exiting Aspen Plus.....	35
2 MODELING COAL COMBUSTION.....	36
Coal Combustion Flowsheet	37
Starting Aspen Plus	37
Opening an Existing Run	38
If You Completed the Simulation in Chapter 1 and Saved the Simulation.....	38
If Your Saved File Solid1.apw is Not Displayed	38
To Access the Examples Folder.....	38
Saving a Run Under a New Name	39
Drawing the Graphical Simulation Flowsheet	39
Changing the Stream Class.....	40
To Change the Global Stream Class	40
Adding Components to the Model	42
Defining Properties.....	43
Change the Heat of Combustion Method for Coal	43
Specify Methods for Calculating Ash Properties	44
Specify the Heat of Combustion for Coal.....	45
Specifying the Air Stream.....	46
Specifying Unit Operation Models	46
Specify the RGibbs Reactor Model.....	47
Specify the RYield Reactor Model.....	48
Specify the Particle Size Distributions.....	49
Specify the Component Attributes for Ash.....	50
Specify the Splits for the SSplit Block.....	52
Defining a Calculator Block	52
Create the Calculator Block.....	53
Define the Calculator Variables.....	53
Specify the Calculations to be Performed	54
Specify When the Calculator Block Should be Run	55
Running the Simulation.....	55
Examining Results.....	56
View the Stream	
View the Block Results.....	
Exiting Aspen Plus.....	
3 MODELING GAS-SOLID SEPARATION.....	60
Gas-Solid Separation.....	60

**CLASES PARTICULARES, TUTORÍAS TÉCNICAS ONLINE
LLAMA O ENVÍA WHATSAPP: 689 45 44 70**

**ONLINE PRIVATE LESSONS FOR SCIENCE STUDENTS
CALL OR WHATSAPP:689 45 44 70**

Starting Aspen Plus	61
Opening an Existing Run	62
If You Completed the Simulation in Chapter 2 and Saved the Simulation	62
If Your Saved File Solid2.apw is Not Displayed	62
To Access the Examples Folder	62
Saving a Run Under a New Name	63
Drawing the Graphical Simulation Flowsheet	63
Changing the Default Particle Size Distribution	64
To Update the Title for This Simulation	64
To Modify the Particle Size Distribution Intervals	64
Updating Particle Size Distributions Previously Entered	65
Specifying the Solids-Handling Blocks	66
To Learn About the Cyclone Model Using Help	68
Running the Simulation	71
Examining Results	71
To View the Stream Results	71
To View the Block Results	72
Exiting Aspen Plus	74
4 MODELING POLYMER RECOVERY	75
Polymer Recovery Flowsheet	76
Starting Aspen Plus	76
To Specify the Application Type and Run Type for the New Run	77
Drawing the Graphical Simulation Flowsheet	77
To Change the Stream Class for the Simulation	79
Specifying Title, Stream Properties, and Global Options	81
To Review the Report Options Specified in the Selected Template	82
Specifying Components	82
Defining Properties	84
Select a Property Method	84
Specify Nonconventional Component Property Methods	85
Specify Parameters Used to Calculate POLYMER Properties	86
Defining Stream Conditions	88
Entering Block Specifications	
Enter Specifications	
To Learn More about	
Enter Specifications	
To Specify That the	
Enter Specifications	

**CLASES PARTICULARES, TUTORÍAS TÉCNICAS ONLINE
LLAMA O ENVÍA WHATSAPP: 689 45 44 70**

**ONLINE PRIVATE LESSONS FOR SCIENCE STUDENTS
CALL OR WHATSAPP:689 45 44 70**

Running the Simulation.....	97
Examining Results.....	97
To View the Stream Results.....	97
To View the Block Results.....	99
Exiting Aspen Plus.....	101
5 CONNECTING TO THE ASPEN PLUS SIMULATION ENGINE	102
GENERAL INFORMATION.....	103
Copyright.....	103
Related Documentation.....	104
Technical Support	105
Online Technical Support Center.....	105
Phone and E-mail.....	105

**CLASES PARTICULARES, TUTORÍAS TÉCNICAS ONLINE
LLAMA O ENVÍA WHATSAPP: 689 45 44 70**

**ONLINE PRIVATE LESSONS FOR SCIENCE STUDENTS
CALL OR WHATSAPP:689 45 44 70**

Introducing Aspen Plus

Aspen Plus can be used to model many processes involving solids. Some of the solids processing applications that have been modeled with Aspen Plus include:

- Bayer process.
- Cement kiln.
- Coal gasification.
- Hazardous waste incineration.
- Iron ore reduction.
- Zinc smelting/roasting.

All of the unit operation models (except Extract) and flowsheeting tools are available for use in modeling solids processing applications.

This book guides you in introducing solids to a simulation in Aspen Plus. The four sessions demonstrate the following concepts:

- Changing the global stream class.
- Defining solid components.
- Defining physical property methods for solid components.
- Defining component attributes for solid components.
- Defining a particle size distribution.
- Modifying the default particle size distribution.
- Accessing component attributes in a Fortran block.
- Modifying component attributes in a block.
- Using solids unit operation models.

Getting Started Modeling Processes with Solids assumes that you have an installed copy of the Aspen Plus software, and that you have done the sessions in *Getting Started Building and Running a Process Model* so that you are familiar with the basics of how to use Aspen Plus.

**CLASES PARTICULARES, TUTORÍAS TÉCNICAS ONLINE
LLAMA O ENVÍA WHATSAPP: 689 45 44 70**

- - -

**ONLINE PRIVATE LESSONS FOR SCIENCE STUDENTS
CALL OR WHATSAPP:689 45 44 70**

Why Use Solids Simulation?

The introduction of solids to a chemical process can affect the process in many ways. In all cases, the heat and mass balances of the process are changed, even if the solid essentially passes through the process as an inert component.

Simulation of the heat and mass balances of a solids process requires physical property models suitable for solid components. The physical property models used to characterize a liquid may not be relevant for solids.

In addition to specialized physical property models for solid components, accurate representation of the solids particle size distribution is required for some processes. For example, the separation efficiency of a cyclone is highly dependent on the size of the particles entrained in the feed gas.

Sessions in this Book

The sessions in this book guide you in building a flowsheet that uses solids.

This book includes the following hands-on sessions:

Follow the steps in this chapter	To learn how to
1 Modeling Coal Drying	Change the global stream class, define nonconventional solid components, specify physical properties for nonconventional solid components, specify streams with nonconventional solid components, and modify component attributes in a unit operation block.
2 Modeling Coal Combustion	Define conventional solid components, define a Fortran block to control solid decomposition.
3 Modeling Gas-Solid Separators	Modify the default particle size intervals; use solids-handling unit operation models.
4 Modeling Polymer Recovery	Use the component attribute GENANAL to characterize a nonconventional component, use the hydrocyclone model, the counter-current decanter model and the cyclone model.

Using Backup Files

We recommend that you perform all sessions sequentially in order to build the entire model. However, you can skip chapters and work on the session of your choice, using backup files containing simulation data.

Aspen results need to do files to

**CLASES PARTICULARES, TUTORÍAS TÉCNICAS ONLINE
LLAMA O ENVÍA WHATSAPP: 689 45 44 70**

- - -

**ONLINE PRIVATE LESSONS FOR SCIENCE STUDENTS
CALL OR WHATSAPP:689 45 44 70**

1 Modeling Coal Drying

In this simulation you will simulate a coal drying process.

You will:

- Change the global stream class.
- Define nonconventional solid components.
- Specify physical properties for nonconventional solid components.
- Specify streams with nonconventional solid components.
- Modify component attributes in a unit operation block.
- Use Help.
- Analyze the results.

Allow about 30 minutes to complete this simulation.

**CLASES PARTICULARES, TUTORÍAS TÉCNICAS ONLINE
LLAMA O ENVÍA WHATSAPP: 689 45 44 70**

- - -

**ONLINE PRIVATE LESSONS FOR SCIENCE STUDENTS
CALL OR WHATSAPP:689 45 44 70**

Coal Drying Flowsheet

The process flow diagram and operating conditions for this simulation are shown in the following figure. A wet coal stream and a nitrogen stream are fed to a drier. There are two products from the drier: a stream of dried coal and a stream of moist nitrogen.

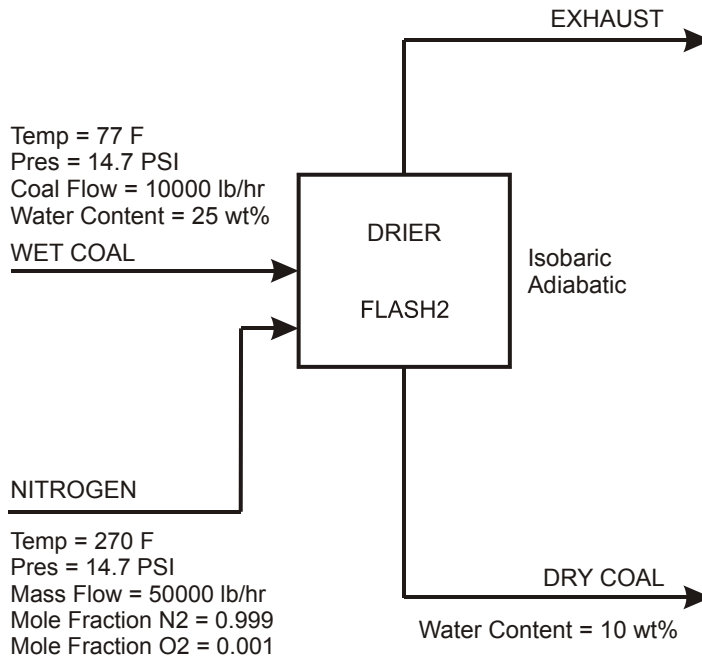

To Start Aspen Plus

- 1 From your desktop, click **Start** and then select **Programs**.
- 2 Select **AspenTech | Aspen Engineering Suite | Aspen Plus 2004.1 | Aspen Plus User Interface**.

The **Aspen Plus Startup** dialog box appears. Aspen Plus displays a dialog box whenever you must enter information or make a selection before proceeding. In this simulation, use an Aspen Plus template.

- 3 Select **Template**.
- 4 Click **OK** to apply this option.

The **New** dialog box appears. Use this dialog box to specify the application type and the run type for the new run. Aspen Plus uses the application type

CLASES PARTICULARES, TUTORÍAS TÉCNICAS ONLINE
LLAMA O ENVÍA WHATSAPP: 689 45 44 70

- - -

ONLINE PRIVATE LESSONS FOR SCIENCE STUDENTS
CALL OR WHATSAPP:689 45 44 70

To Specify the Application Type and Run Type for the New Run

- 1 Select the **Solids with English Units** template.

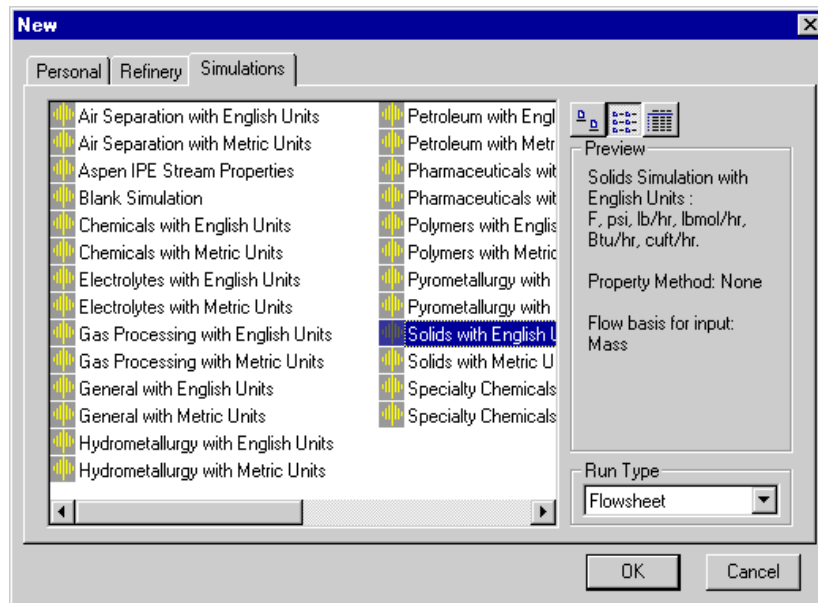

The default run type, **Flowsheet**, is appropriate for this simulation.

- 2 Click **OK** to apply these options.

It takes a few seconds for Aspen Plus to apply these options.



Note: If the **Connect to Engine** dialog box appears, see Chapter 5.

The Aspen Plus main window is now active.

Drawing the Graphical Simulation Flowsheet

In this simulation, begin building the process flowsheet. Since you will enter your own block and stream IDs, turn off the automatic naming of blocks and streams, which provide these IDs automatically.

- 1 From the **Tools** menu, select **Options**.

The

- 2 Sel

- 3 Cle

Au

CLASES PARTICULARES, TUTORÍAS TÉCNICAS ONLINE
LLAMA O ENVÍA WHATSAPP: 689 45 44 70

ONLINE PRIVATE LESSONS FOR SCIENCE STUDENTS
CALL OR WHATSAPP:689 45 44 70

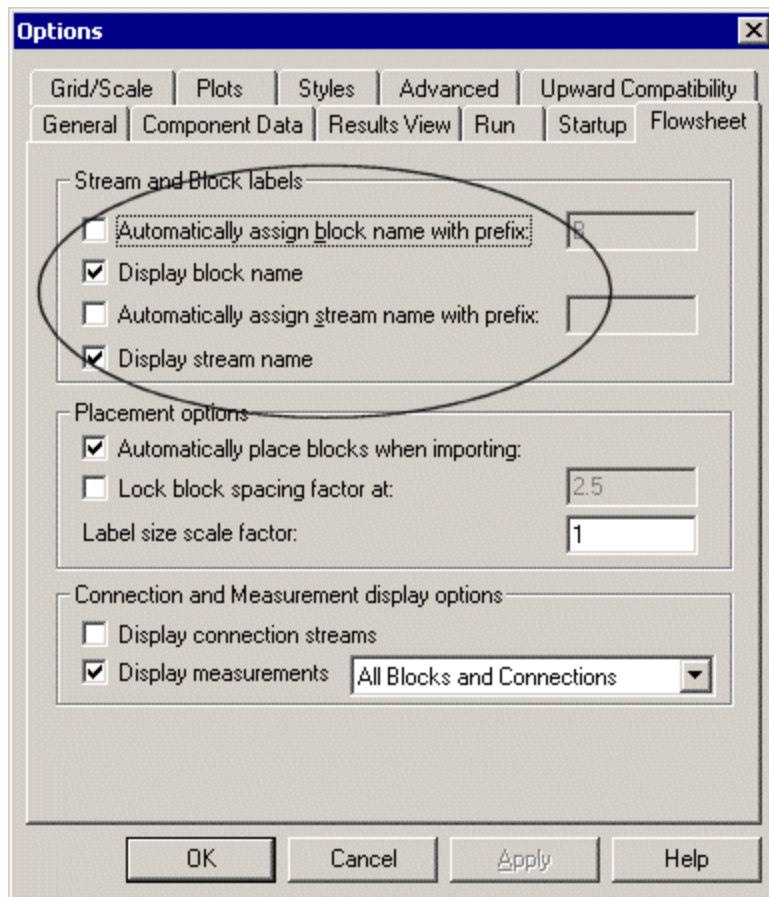

- 4 Click **OK** to close the **Options** dialog box and apply the changes.

The simulation flowsheet shown in the following figure feeds the WET-COAL stream and the NITROGEN stream to an RStoic model. In the RStoic block, a portion of the coal reacts to form water. Because the RStoic model has a single outlet stream, use a Flash2 model to separate the dried coal from the moist nitrogen.

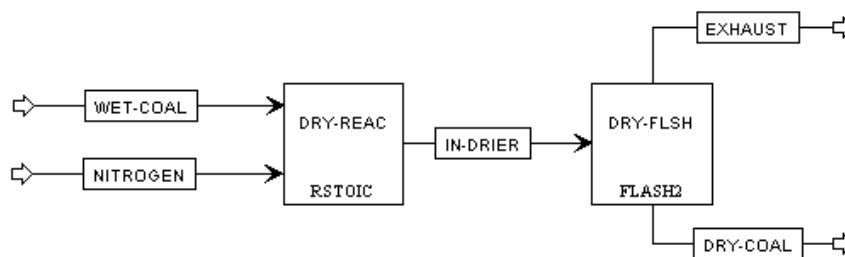

- 5 Place the flowsheet blocks and streams to create the graphical simulation.

CLASES PARTICULARES, TUTORÍAS TÉCNICAS ONLINE
 LLAMA O ENVÍA WHATSAPP: 689 45 44 70

- 6 As

 ONLINE PRIVATE LESSONS FOR SCIENCE STUDENTS
 CALL OR WHATSAPP:689 45 44 70

unit operation models to simulate a single piece of equipment. Also, the simulation flowsheet defines an extra stream (IN-DRIER) to connect the two simulation unit operation models. There is no real stream that corresponds to the simulation stream IN-DRIER.

- 7 Click  to continue.

The **Flowsheet Complete** dialog box appears.

Stream Classes and Substreams

Stream classes are used to define the structure of simulation streams when inert solids are present.

The default stream class for most simulations is CONVEN. The CONVEN stream class has a single substream: the MIXED substream. By definition, all components in the MIXED substream participate in phase equilibrium whenever flash calculations are performed.

To introduce inert solid components to a simulation, you must include one or more additional substreams. Aspen Plus has two other types of substreams available: the CISOLID substream type and the NC substream type.

The CISOLID substream (Conventional Inert Solid) is used for homogeneous solids that have a defined molecular weight. The NC substream (Nonconventional) is used for heterogeneous solids that have no defined molecular weight. Both the CISOLID substream and the NC substream give you the option of including a Particle Size Distribution (PSD) for the substream.

Substreams are combined in different ways to form different stream classes. The MIXNCPSD stream class contains two substreams: MIXED and NCPSD.

The default stream class of the Solids application type, MIXCISLD, is insufficient for this simulation since you will use an NC substream with a particle size distribution for the feed coal. In this simulation, use the MIXNCPSD stream class.

Specifying Title, Stream Properties, and Global Options

- 1 Click **OK** to continue.

The **Data Browser** window appears. The **Setup | Specifications |**

CLASES PARTICULARES, TUTORÍAS TÉCNICAS ONLINE
Use **LLAMA O ENVÍA WHATSAPP: 689 45 44 70**

pro

with

The

sim

ONLINE PRIVATE LESSONS FOR SCIENCE STUDENTS
CALL OR WHATSAPP:689 45 44 70

It is always good practice to describe your simulation by entering a title for the simulation.

- 2 In the **Title** field, enter the title *Getting Started with Solids – Simulation 1*.

The Solids with English Units application type sets the following global defaults for solids applications:

- *ENG* units (English Engineering Units).
- *Mass Flow Basis* for all flow inputs.
- The global stream class is *MIXCISLD*.

- 3 In the Stream Class field, click and select *MIXNCPSD*.

Global Description Accounting Diagnostics

Title: Getting Started with Solids - Simulation 1

Units of measurement

Input data: ENG

Output results: ENG

Global settings

Run type: Flowsheet

Input mode: Steady-State

Stream class: MIXNCPSD

Flow basis: Mass

Ambient pressure: 14.69595 psi

Ambient temp.: 50 F

Valid phases:

Free water: No

To Review the Report Options Specified in the Selected Template

- 4 From the Data Browser, click the **Setup | Report Options** form.
- 5 Click the **Stream** tab.

CLASES PARTICULARES, TUTORÍAS TÉCNICAS ONLINE
LLAMA O ENVÍA WHATSAPP: 689 45 44 70

- - -

ONLINE PRIVATE LESSONS FOR SCIENCE STUDENTS
CALL OR WHATSAPP:689 45 44 70

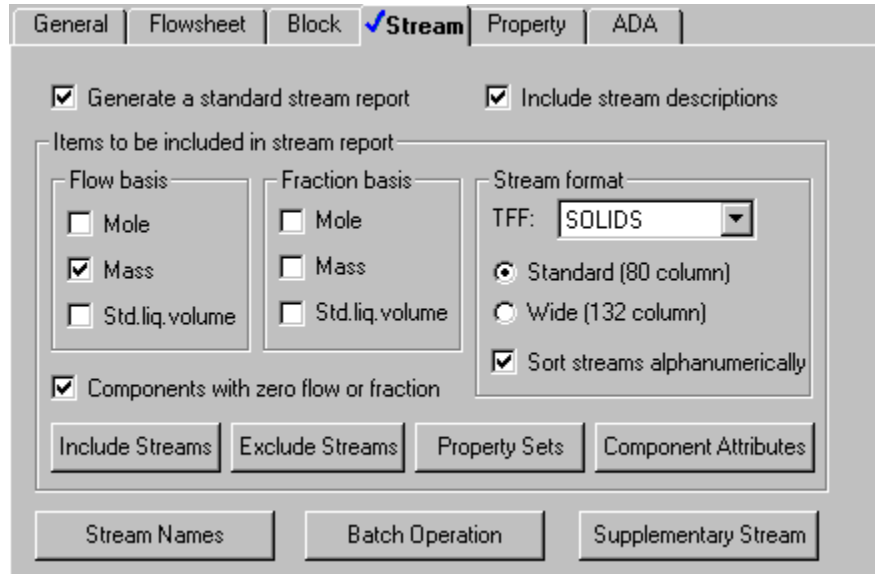

Since you chose the Solids with English Units application type when you started this simulation, Aspen Plus has set the following defaults for calculating and reporting stream properties:

- The component mass flow rates will be included in the stream report.
- The stream results will be displayed using the *SOLIDS* stream format.
- Property set *ALL-SUBS* (properties for the entire stream, all substreams combined) will be reported for each stream.

6 Click **Property Sets** to view the selected property sets.

7 Click **Close** to return to the **Stream** sheet.

8 Click  to continue.

The **Components | Specifications | Selection** sheet appears.

Specifying Components

The **Components | Specifications | Selection** sheet is used to enter the components present in the simulation. The components in this simulation are H₂O, N₂, O₂, and coal.

1 In the first four **Component ID** fields, enter H₂O, N₂, O₂, and COAL.

Because H₂O, N₂, O₂ and even COAL are present in the databanks, WATER, NITROGEN, OXYGEN, and COAL appear in the Component name field. Aspen Plus has a component named COAL in its SOLIDS databank, but

2 In the key

By
Con
cal
nor

CLASES PARTICULARES, TUTORÍAS TÉCNICAS ONLINE
LLAMA O ENVÍA WHATSAPP: 689 45 44 70

ONLINE PRIVATE LESSONS FOR SCIENCE STUDENTS
CALL OR WHATSAPP:689 45 44 70

- 3 From the COAL **Type** field, click  and select *Nonconventional*.

The **Components | Specifications | Selection** sheet is now complete:

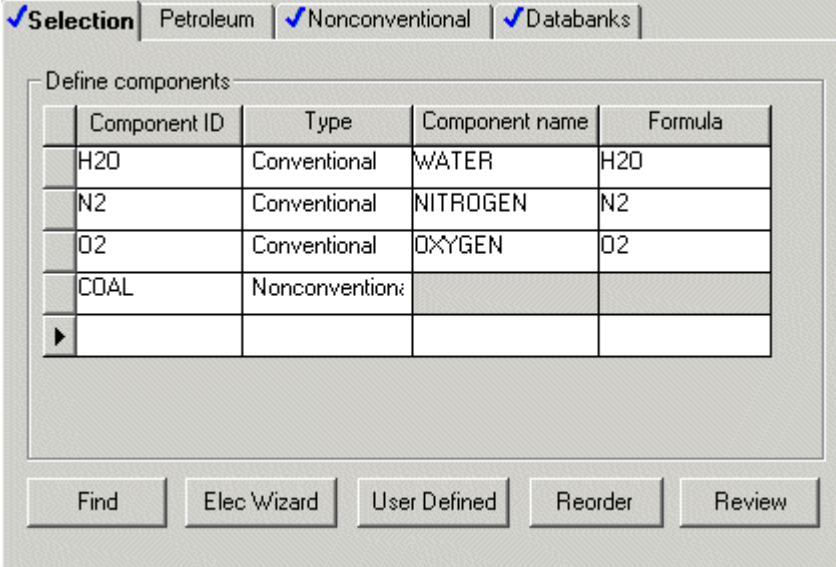

Component ID	Type	Component name	Formula
H2O	Conventional	WATER	H2O
N2	Conventional	NITROGEN	N2
O2	Conventional	OXYGEN	O2
COAL	Nonconventional		

- 4 Click  to continue.

The **Properties | Specifications | Global** sheet appears.

Defining Properties

The **Properties | Specifications | Global** sheet is used to select the thermodynamic methods used to calculate properties such as K-values, enthalpy, and density. Property methods in Aspen Plus are categorized into various process types.

Because the physical property methods for solid components are the same for all property methods, select a property method based on the conventional components in the simulation.

The IDEAL property method (Ideal gas and Raoult's Law, as the prompt indicates) is a good choice for this simulation, since the process involves the conventional components H₂O, N₂, and O₂, at low pressure.

- 1 In the **Base method** field, click  and select IDEAL.

CLASES PARTICULARES, TUTORÍAS TÉCNICAS ONLINE
LLAMA O ENVÍA WHATSAPP: 689 45 44 70

ONLINE PRIVATE LESSONS FOR SCIENCE STUDENTS
CALL OR WHATSAPP:689 45 44 70

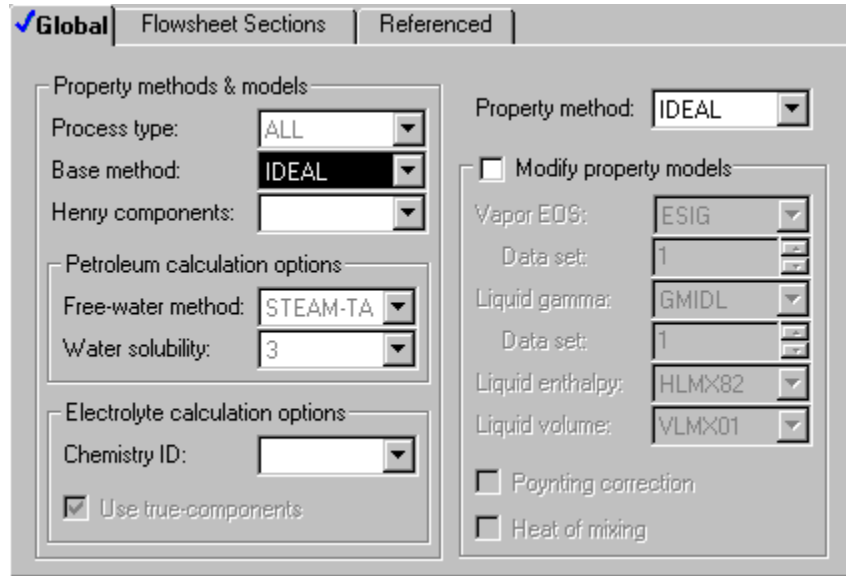

2 Click  to continue.

The **Properties | Advanced | NC Props | Property Methods** sheet appears.

Specifying Nonconventional Solid Physical Property Models

The **Properties | Advanced | NC Props | Property Methods** sheet is used to specify the models used to calculate the nonconventional solid properties. Because nonconventional components are heterogeneous solids that do not participate in chemical or phase equilibrium, the only physical properties that are calculated for nonconventional components are enthalpy and density.

In this simulation, use the HCOALGEN and the DCOALIGT models to calculate the enthalpy and density of coal.

1 In the **Model name** field for **Enthalpy**, click  and select *HCOALGEN*.

The component attributes PROXANAL, ULTANAL, and SULFANAL are automatically included in the **Required component attributes for the selected models** field for coal when you select HCOALGEN. Also, four **Option code value** fields with values of 1 appear.

Aspen Plus uses component attributes to represent nonconventional



cor
cal
ulti

The
the
and

CLASES PARTICULARES, TUTORÍAS TÉCNICAS ONLINE
LLAMA O ENVÍA WHATSAPP: 689 45 44 70

ONLINE PRIVATE LESSONS FOR SCIENCE STUDENTS
CALL OR WHATSAPP:689 45 44 70

For More Information on the HCOALGEN Model

- 2 In the toolbar, click .
- 3 Click the **Model name** field for Enthalpy where you have selected *HCOALGEN*.
A small help window appears with the message: "Coal enthalpy model. Based on the Option code values entered, component attributes Ultanal, Sulfanal, and Proxanal may be required. For details see [Coal enthalpy](#)."
4 From the help window, click the [Coal enthalpy](#) hypertext link.
A larger help window appears, providing information on HCOALGEN, the General Coal Enthalpy Model.
- 5 Use the vertical scrollbar to access the **HCOALGEN Option Codes** table.
The help defines what each option code value means and the calculation methods available.
The calculation methods represented by the option code value defaults of 1, 1, 1 and 1 are acceptable for this simulation.
- 6 Click  in the top right corner to close the help window.
- 7 In the **Model name** field for **Density**, click  and select DCOALIGT.
The Property Methods sheet is complete:

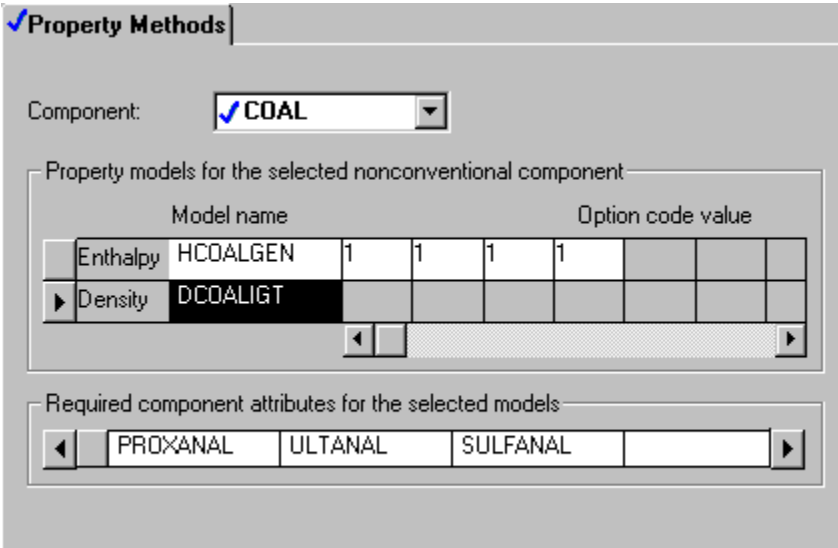

Property Methods

Component: COAL

Property models for the selected nonconventional component

	Model name	Option code value			
Enthalpy	HCOALGEN	1	1	1	1
Density	DCOALIGT				

Required component attributes for the selected models

PROXANAL | ULTANAL | SULFANAL

8 Click

CLASES PARTICULARES, TUTORÍAS TÉCNICAS ONLINE
LLAMA O ENVÍA WHATSAPP: 689 45 44 70

ONLINE PRIVATE LESSONS FOR SCIENCE STUDENTS
CALL OR WHATSAPP:689 45 44 70

The **Required Properties Input Complete** dialog box appears:

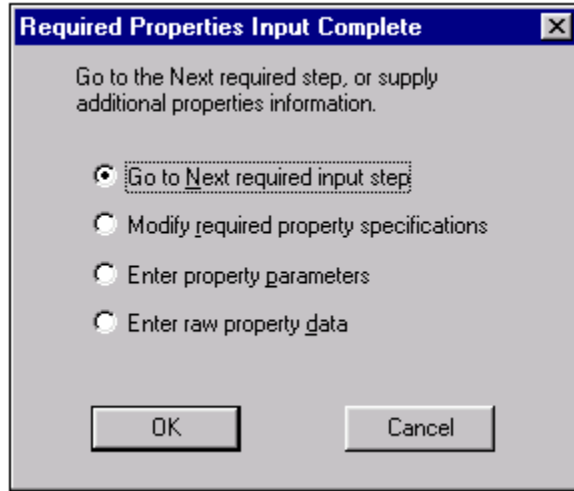

Correct representation of physical properties is an essential component of process modeling. For many simulations, the only physical property specification that you must provide is the selection of a property method. The **Required Properties Input Complete** dialog box shows that the Aspen Plus physical property system has many optional capabilities that you can use to increase the accuracy of physical property calculations.

- 9 Click **OK** to continue.

Entering Stream Data

The **Streams | NITROGEN | Input | Specifications** sheet appears. To specify a stream, Aspen Plus requires two thermodynamic specifications, and enough information to calculate the flow rate of each component.

Specifying the Nitrogen Stream

- 1 Enter the following specifications:

Temperature	270 F
Pressure	14.7 psi
Total flow	Mass 50000 lb/hr
Composition	Mole-Frac

- 2 Enter the following mole fractions:

N₂	CLASES PARTICULARES, TUTORÍAS TÉCNICAS ONLINE
O₂	LLAMA O ENVÍA WHATSAPP: 689 45 44 70

ONLINE PRIVATE LESSONS FOR SCIENCE STUDENTS
CALL OR WHATSAPP:689 45 44 70

Specifications | Flash Options | PSD | Component Attr. | EO Options

Substream name: MIXED

State variables:

Temperature:

Pressure:

Total flow:

Solvent:

Composition:

Mole-Frac:

Component	Value
H2O	
N2	0.999
O2	0.001

Total:

3 Click to continue.

Specifying the Wet Coal Feed Stream

The **Streams | WET-COAL | Input | Specifications** sheet appears. Substream MIXED appears by default. To access the NCPSD substream:

- 4 In the **Substream name** field, click and select *NCPSD*.
- 5 For the NCPSD substream, enter the following specifications:

Temperature 77.0 F

Pressure 14.7 psi

COAL component flow 10000 lb/hr

6 Click .

The **Streams | WET-COAL | Input | PSD** sheet appears.

By default, Aspen Plus uses a particle size distribution of 10 size ranges covering 20 microns each. The default size ranges are appropriate for this simulation. On this sheet, enter the weight fraction of coal in each size range.

- 7 On the last four **Weight Fraction** fields, enter the following values:

Interval	Weight Fraction
7	
8	
9	
10	

7	<p>CLASES PARTICULARES, TUTORÍAS TÉCNICAS ONLINE LLAMA O ENVÍA WHATSAPP: 689 45 44 70</p> <p>---</p> <p>ONLINE PRIVATE LESSONS FOR SCIENCE STUDENTS CALL OR WHATSAPP:689 45 44 70</p>
8	
9	
10	

Specifications Flash Options PSD Component Attr. EO Options

Substream name: NCPSD

Particle size distribution

PSD ID: Units:

	Interval	Lower limit	Upper limit	Weight fraction
1	0	20		
2	20	40		
3	40	60		
4	60	80		
5	80	100		
6	100	120		
7	120	140		0.1
8	140	160		0.2
9	160	180		0.3
▶ 10	180	200		0.4

8 Click  to continue.

The **Streams | WET-COAL | Input | Component Attr.** sheet appears. On this sheet, enter the component attributes for the component COAL in the NCPSD substream. The values in PROXANAL, ULTANAL, and SULFANAL are defined as weight % on a dry basis, except for Moisture in PROXANAL.

9 Enter the component attribute values for coal. For the attribute PROXANAL, enter these values:

Element	Value
Moisture	25.0
FC	45.1
VM	45.7
Ash	9.2

CLASES PARTICULARES, TUTORÍAS TÉCNICAS ONLINE
LLAMA O ENVÍA WHATSAPP: 689 45 44 70

ONLINE PRIVATE LESSONS FOR SCIENCE STUDENTS
CALL OR WHATSAPP:689 45 44 70

Specifications Flash Options PSD **Component Attr.** EO Options

Substream name: NCPSD

Component ID: COAL

Attribute ID: PROXANAL

Element	Value
MOISTURE	25
FC	45.1
VM	45.7
ASH	9.2

10 In the **Attribute ID** field, click and select *ULTANAL*.

11 For the attribute *ULTANAL*, enter these values:

Element	Value
Ash	9.2
Carbon	67.1
Hydrogen	4.8
Nitrogen	1.1
Chlorine	0.1
Sulfur	1.3
Oxygen	16.4

Specifications Flash Options PSD **Component Attr.** EO Options

Substream name: NCPSD

Component ID: COAL

Attribute ID: ULTANAL

Element	Value
ASH	9.2
CARBON	67.1
HYDROGEN	4.8
NITROGEN	1.1
CHLORINE	0.1
SULFUR	1.3

CLASES PARTICULARES, TUTORÍAS TÉCNICAS ONLINE
LLAMA O ENVÍA WHATSAPP: 689 45 44 70

12 In

ONLINE PRIVATE LESSONS FOR SCIENCE STUDENTS
CALL OR WHATSAPP:689 45 44 70

13 For the attribute SULFANAL, enter these values:

Element	Value
Pyritic	0.6
Sulfate	0.1
Organic	0.6

Specifications | Flash Options | PSD | **Component Attr.** | EO Options

Substream name: NCPD

Component ID: COAL

Attribute ID: SULFANAL

Element	Value
PYRITIC	0.6
SULFATE	0.1
ORGANIC	0.6

The values meet the following consistency requirements:

- SULFANAL values sum to the ULTANAL value for sulfur.
- ULTANAL value for ash equals the PROXANAL value for ash.
- ULTANAL values sum to 100.
- PROXANAL values for FC, VM, and ASH sum to 100.

14 Click  to continue.

The **Blocks | DRY-FLSH | Input | Specifications** sheet appears.

Specifying Blocks

The unit operation models RStoic and Flash2 simulate a single piece of plant equipment for drying coal. Nitrogen provides the heat for coal drying. Both the RStoic and Flash2 models are isobaric and adiabatic.

Specifying the Flash2 Block

On the

1 In
pla

2 In

3 In

CLASES PARTICULARES, TUTORÍAS TÉCNICAS ONLINE
LLAMA O ENVÍA WHATSAPP: 689 45 44 70

ONLINE PRIVATE LESSONS FOR SCIENCE STUDENTS
CALL OR WHATSAPP:689 45 44 70

Specifications | Flash Options | Entrainment | Utilities

Flash specifications

Heat duty: 0 Btu/hr



Pressure: 14.7 psi

Valid phases: Vapor-Liquid

- 4 Click  to continue.

Specifying the RStoic Block

The **Blocks | DRY-REAC | Setup | Specifications** sheet appears.

- 5 In the **Pressure** field, enter 14.7 psi.
- 6 In the second **Operating conditions** field, click  and select *Heat duty*.
- 7 In the **Heat duty** field, enter 0.0 Btu/hr.
- 8 Click  to continue.

The **Blocks | DRY_REAC | Setup | Reactions** sheet appears.

This RStoic block models the drying of coal. Although coal drying is not normally considered a chemical reaction, you are using an RStoic block to convert a portion of the coal to form water. The following equation is the chemical reaction for coal drying:

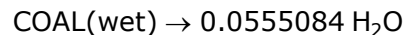

Aspen Plus treats all nonconventional components as if they have a molecular weight of 1.0. The reaction indicates that 1 mole (or 1 lb.) of coal reacts to form 0.0555084 mole (or 1 lb.) of water.

To **CLASES PARTICULARES, TUTORÍAS TÉCNICAS ONLINE**
 1 Click **LLAMA O ENVÍA WHATSAPP: 689 45 44 70**

The aut
 aut

 2 In **ONLINE PRIVATE LESSONS FOR SCIENCE STUDENTS**
CALL OR WHATSAPP:689 45 44 70

- 3 In the **Reactants Coefficient** field, enter 1.

Note that the stoichiometric coefficient for reactants is displayed as negative.

- 4 In the **Products Component** field, click  and select H2O.

- 5 In the **Products Coefficient** field, enter .0555084.

The conversion for this reaction must be set to achieve the proper amount of drying.

- 6 In the **Products generation** section, select the *Fractional conversion* option.

- 7 In the **Fractional conversion** field, enter 0.2 and in the **of component** field, click  and select COAL.

The fraction conversion of Coal of 0.2 is a temporary value that you will override later with a Calculator block.

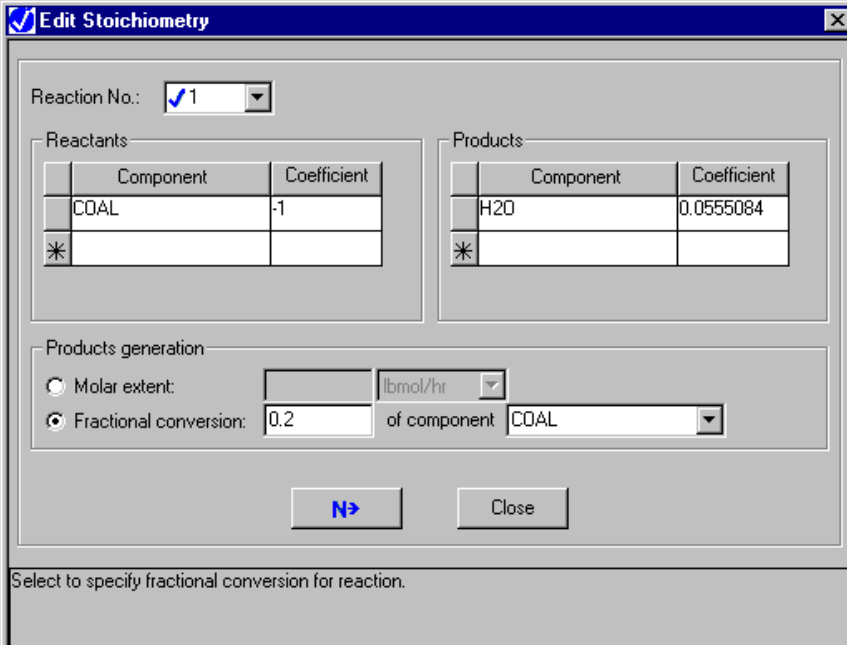

Reactants		Products	
Component	Coefficient	Component	Coefficient
COAL	-1	H2O	0.0555084
*		*	

Products generation

Molar extent: lbmol/hr

Fractional conversion: of component

Select to specify fractional conversion for reaction.

- 8 Click **Close** to return to the **Blocks | DRY-REAC | Setup | Reaction** sheet.

Updating the Moisture Content

Drying the coal changes its component attribute for moisture in the
Pro
and
att

- 9 Click
need

CLASES PARTICULARES, TUTORÍAS TÉCNICAS ONLINE
LLAMA O ENVÍA WHATSAPP: 689 45 44 70

ONLINE PRIVATE LESSONS FOR SCIENCE STUDENTS
CALL OR WHATSAPP:689 45 44 70

The **Blocks | DRY-REAC | Setup | Component Attr.** sheet appears. On this sheet, enter the values for component attributes that change in this RStoic block. If you do not enter an attribute value, the attribute does not change.

- 10** In the **Substream** field, click and select *NCPD*.
- 11** In the **Component ID** field, click and select *COAL*.
- 12** In the **Attribute ID** field, click and select *PROXANAL*.
- 13** In the **Moisture** field, enter a value of 1.0. (The moisture content of 1.0 is a temporary value that you will override later with a Fortran block.)

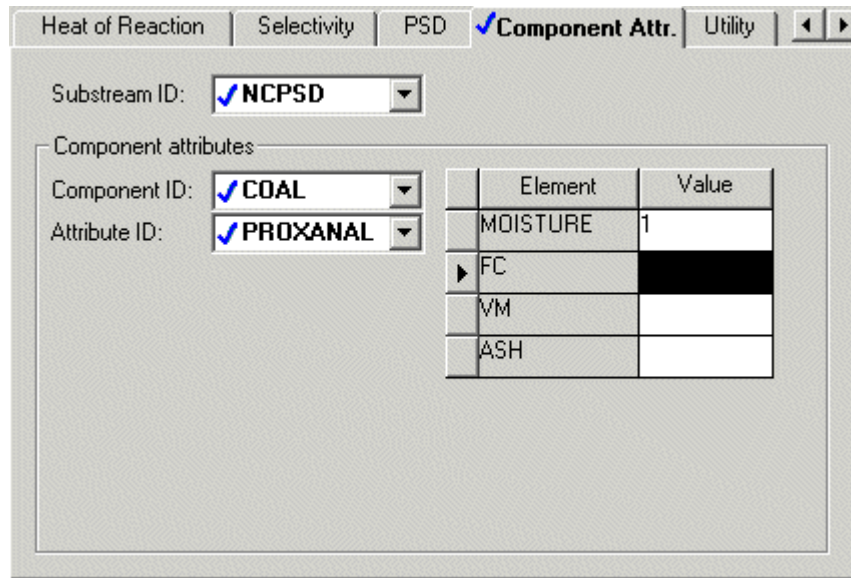

- 14** Click to continue.

The **Required Input Complete** dialog box appears.

Although you could run your simulation now, you have not yet created the Calculator block to control the drying.

- 15** Click **Cancel**.
- 16** Close the **Data Browser**.

Using a Calculator Block to

Co CLASES PARTICULARES, TUTORÍAS TÉCNICAS ONLINE
LLAMA O ENVÍA WHATSAPP: 689 45 44 70

The ma
followi

- Wa
- Fra
- Wa

ONLINE PRIVATE LESSONS FOR SCIENCE STUDENTS
CALL OR WHATSAPP:689 45 44 70

$$COALIN * \frac{H2OIN}{100} = COALOUT * \frac{H2OOUT}{100} + COALIN * CONV \quad (1)$$

$$COALIN = COALOUT + COALIN * CONV \quad (2)$$

Where:

- COALIN = Mass flow rate of coal in stream WET-COAL
- COALOUT = Mass flow rate of coal in stream IN-DRIER
- H2OIN = Percent moisture in the coal in stream WET-COAL
- H2ODRY = Percent moisture in the coal in stream IN-DRIER
- CONV = Fractional conversion of coal to H₂O in the block DRY-REAC

Equation 1 is the material balance for water, and equation 2 is the overall material balance. These equations can be combined to yield equation 3:

$$CONV = \frac{(H2OIN - H2OOUT)}{(100 - H2OOUT)} \quad (3)$$

Use equation 3 in a Calculator block to ensure these three specifications are consistent.

The Calculator block specifies the moisture content of the dried coal and calculates the corresponding conversion of coal to water.

Using a Calculator block to set specifications allows you to run different cases easily.

- 1 From the **Data** menu, select **Flowsheeting Options | Calculator**.

The **Calculator** object manager appears.

- 2 Click **New** to create a new Calculator block.

The **Create new ID** dialog box appears, displaying an automatically generated Calculator ID, C-1.

- 3 Delete the ID C-1 and enter the ID *WATER* and click **OK**.

The **Flowsheeting Options | Calculator | WATER | Input | Define** sheet appears.

Use this sheet to access the flowsheet variables you want to use in the Calculator block. Define the three Calculator variables from equation 3: H2OIN, H2ODRY, and CONV.

H2OIN is the water content of the feed coal. The H2OIN variable accesses the first element (percent moisture) of the component attribute PROXANAL for component COAL in the NCPD substream of stream WET-COAL.

Cre

- 1 Click

The

- 2 In

CLASES PARTICULARES, TUTORÍAS TÉCNICAS ONLINE
LLAMA O ENVÍA WHATSAPP: 689 45 44 70

ONLINE PRIVATE LESSONS FOR SCIENCE STUDENTS
CALL OR WHATSAPP:689 45 44 70

The **Variable Definition** dialog box appears.

3 Under **Category**, select *Streams*.

4 In the **Reference** frame, in the **Type** field, click and select *Compattr-Var* since the variable is a component attribute.

When you are specifying variables, Aspen Plus displays the other fields necessary to complete the variable definition. In this case, the **Stream** field appears.

5 In the **Stream** field, click and select *WET-COAL*.

The **Substream** and **Component** fields appear. In this example, do not modify the default choice of *NCPSD* in the **Substream** field.

6 In the **Component** field, click and select *COAL*.

The **Attribute** field appears.

7 In the **Attribute** field, click and select *PROXANAL*.

8 In the **Element** field, enter 1. Press Enter.

CLASES PARTICULARES, TUTORÍAS TÉCNICAS ONLINE
LLAMA O ENVÍA WHATSAPP: 689 45 44 70

- - -

ONLINE PRIVATE LESSONS FOR SCIENCE STUDENTS
CALL OR WHATSAPP:689 45 44 70

The blue check mark next to H2OIN in the **Variable name** field indicates that the definition of variable H2OIN is complete:

Variable Definition

Select a variable category and reference

Variable name: H2OIN

Category

All

Blocks

Streams

Model Utility

Property

Reactions

Reference

Type:

Stream:

Substream:

Component:

Attribute:

Element:

Information flow

Import variable Export variable Tear variable

Parameter information

Physical type:

Units:

Initial value:

EO input

Open variable:

Description:

9 Click **Close** to close the dialog box.

CLASES PARTICULARES, TUTORÍAS TÉCNICAS ONLINE
LLAMA O ENVÍA WHATSAPP: 689 45 44 70

ONLINE PRIVATE LESSONS FOR SCIENCE STUDENTS
CALL OR WHATSAPP:689 45 44 70

Creating the Other Variables

CONV and H2ODRY are block variables in the DRY-REAC block. CONV is the fractional conversion of the first (and only) reaction. H2ODRY is the moisture content of the coal leaving the RStoic block.

- 10** Click **New** to create another variable, CONV. Create the new CONV and H2ODRY variables as shown:

The screenshot shows the 'Variable Definition' dialog box. The 'Variable name' is set to 'CONV'. The 'Category' is 'Blocks'. The 'Reference' section is filled with: Type: 'Block-Var', Block: 'DRY-REAC', Variable: 'CONV', Sentence: 'CONV', and ID1: '1'.

The screenshot shows the 'Variable Definition' dialog box. The 'Variable name' is set to 'H2ODRY'. The 'Category' is 'Blocks'. The 'Reference' section is filled with: Type: 'Block-Var', Block: 'DRY-REAC', Variable: 'COMPATT', Sentence: 'COMP-ATTR', ID1: 'NCPST', ID2: 'COAL', ID3: 'PROXANAL', and Element: 'H'.

- 11** Click **Close** to close the dialog box.

- 12** Click  to continue.

CLASES PARTICULARES, TUTORÍAS TÉCNICAS ONLINE
LLAMA O ENVÍA WHATSAPP: 689 45 44 70

ONLINE PRIVATE LESSONS FOR SCIENCE STUDENTS
CALL OR WHATSAPP:689 45 44 70

Calculating the Conversion Variable

The **Calculator | WATER | Input | Calculate** sheet appears. Use this sheet to enter the Fortran statements you want Aspen Plus to execute to set H2ODRY and to calculate CONV from equation 3.

13 Enter the following Fortran statements:

```
H2ODRY = 10.0
```

```
CONV = (H2OIN - H2ODRY) / (100 - H2ODRY)
```



Note: Ensure that there are 6 spaces at the beginning of each line of the Fortran statements.

14 Click  to continue.

Specifying When the Calculator Block Should Run

The **Calculator | WATER | Input | Sequence** sheet appears. Use this sheet to specify when Aspen Plus should execute this Calculator block. Since you have used inline Fortran to modify the specifications for the RStoic block DRY-REAC, this Calculator block should execute immediately prior to DRY-REAC.

15 In the **Execute** field, click  and select *Before*.

16 In the **Block type** field, click  and select *Unit operation*.

17 In the **Block name** field, click  and select *DRY-REAC*.

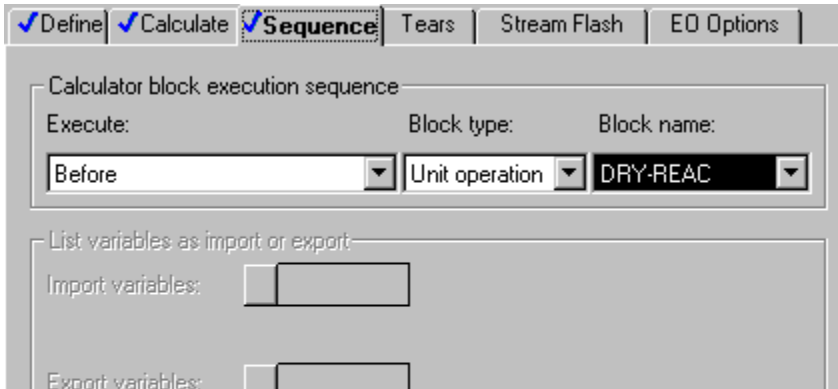

Calculator block execution sequence

Execute: Block type: Block name:

List variables as import or export

Import variables:

Export variables:

CLASES PARTICULARES, TUTORÍAS TÉCNICAS ONLINE
LLAMA O ENVÍA WHATSAPP: 689 45 44 70

- - -

ONLINE PRIVATE LESSONS FOR SCIENCE STUDENTS
CALL OR WHATSAPP:689 45 44 70

18 Click  to continue.

The **Required Input Complete** dialog box appears.

Running the Simulation

1 Click **OK** to run the simulation.

The **Control Panel** window appears, allowing you to monitor and interact with the Aspen Plus simulation calculations.

As Aspen Plus performs the analysis, status messages display in the **Control Panel**.

The simulation completes without warnings or errors.

When the calculations finish, the message *Results Available* appears in the status area at the bottom right of the main window.

2 When the *Simulation Run Completed* message appears in the status bar, close the **Control Panel** window.

3 Examine the results of your simulation.

Examining Simulation Results

To View the Stream Results

1 From the **Control Panel**, click .

The **Results Summary | Run Status | Summary** sheet appears, indicating that the simulation completed normally.

2 Click  to move to the next sheet with results.

The **Results Summary | Streams | Material** sheet appears.

CLASES PARTICULARES, TUTORÍAS TÉCNICAS ONLINE
LLAMA O ENVÍA WHATSAPP: 689 45 44 70

- - -

ONLINE PRIVATE LESSONS FOR SCIENCE STUDENTS
CALL OR WHATSAPP:689 45 44 70

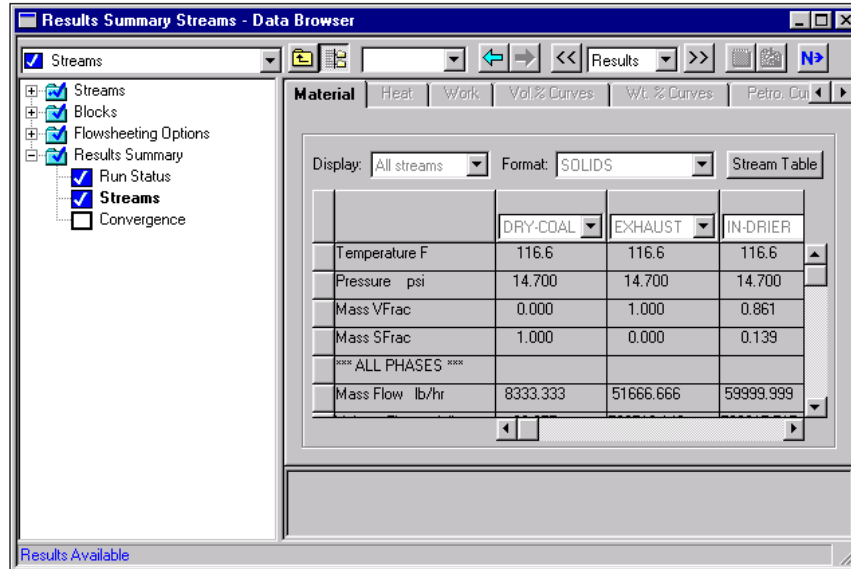

- 3 Review the results on this sheet. Since this is a scrolling sheet, use the scrollbars to review results that are off the screen.

Aspen Plus populates the **Results Summary | Stream | Material** sheet using the SOLIDS format. The SOLIDS format reports results in three sections.

The top section reports the thermodynamic variables temperature pressure, vapor fraction, and solid fraction for the stream.

The second section, beginning with *****ALL PHASES*****, reports properties and component mass flow rates summed over all substreams. Examination of the component mass flow rates indicates that 1667 lb/hr of H₂O are removed from the coal by the drying process.

The third section, beginning with ***** SUBSTREAM NCPD *****, displays information that is appropriate only for the NCPD substream. In this case, it displays the component attributes for coal, and the overall particle size distribution for the NCPD substream. Note that the moisture in the PROXANAL is different for stream DRY-COAL and stream WET-COAL.

Stream summary results can also be displayed one substream at a time, by using the FULL format.





- 4 In the **Format** field, click  and select *FULL*.
- 5 Examine the results reported for the MIXED and NCPD substreams. When you are done, return to the SOLIDS Format.
- 6 From the Data Browser, expand the **Blocks** folder and select the **DRY-**

FL CLASES PARTICULARES, TUTORÍAS TÉCNICAS ONLINE
 LLAMA O ENVÍA WHATSAPP: 689 45 44 70

ONLINE PRIVATE LESSONS FOR SCIENCE STUDENTS
 CALL OR WHATSAPP:689 45 44 70

Summary	Balance	Phase Equilibrium
Block results summary		
Outlet temperature:	116.621848	F
Outlet pressure:	14.7	psi
Vapor fraction:	1	
Heat duty:	0	Btu/hr
Net duty:	0	Btu/hr
1st liquid / Total liquid:		

To View the Block Results

- 7 Click  to move to the next sheet with results.
The **DRY-FLSH | Results | Balance** sheet appears. This sheet is used to report the overall mass and energy balance for the block.
- 8 Click  to move to the next sheet with results.
The **DRY-FLSH | Results | Phase Equilibrium** sheet appears. On this sheet, Aspen Plus reports the total molar flow rate, liquid mole fractions, vapor mole fractions and K-values. In this block, there is no liquid phase, so the liquid mole fractions and K-values refer to a hypothetical liquid phase.
- 9 Click  to move to the next sheet with results.
The **DRY-FLSH | Stream Results | Material** sheet appears. This is similar to the **Results Summary | Streams | Material** sheet, but only lists streams entering or leaving this block.
- 10 Click  to move to the next sheet with results.
The **DRY-REAC | Results | Summary** sheet appears. This sheet, like the **DRY-FLSH | Results | Summary** sheet, displays the mixture thermodynamic results for the block, such as temperature.

CLASES PARTICULARES, TUTORÍAS TÉCNICAS ONLINE
LLAMA O ENVÍA WHATSAPP: 689 45 44 70

- - -

ONLINE PRIVATE LESSONS FOR SCIENCE STUDENTS
CALL OR WHATSAPP:689 45 44 70

Summary	Balance	Phase Equilibrium	Reactions	Selectivity
RStoic results				
Outlet temperature:	116.62193	F		
Outlet pressure:	14.7	psi		
Heat duty:	0	Btu/hr		
Net heat duty:	0	Btu/hr		
Vapor fraction:	1			
1st liquid / Total liquid:				

- 11 Click  to move to the next sheet with results.

The **DRY-REAC | Results | Balance** sheet appears. This sheet displays the mass and energy balance for the block. Because this block contains a reaction between the NCPD substream and the MIXED substream, neither the conventional components nor the nonconventional are in mass balance. The total mass balance for the stream shows a very small relative difference.

- 12 Click  to move to the next sheet with results.

The **DRY-REAC | Results | Phase Equilibrium** sheet appears. This sheet serves the same function as the **DRY-FLSH | Results | Phase Equilibrium** sheet.

Exiting Aspen Plus

When you are finished working with this model, save your simulation and exit Aspen Plus as follows:

- 1 From the **Aspen Plus** menu bar, select **File | Save as**.

The **Save as** dialog box appears.

- 2 In the **Save as** field, enter *Solid1*.

- 3 Click **Save**.

Asp
Sol
fiel

CLASES PARTICULARES, TUTORÍAS TÉCNICAS ONLINE
LLAMA O ENVÍA WHATSAPP: 689 45 44 70

- 4 Fro



ONLINE PRIVATE LESSONS FOR SCIENCE STUDENTS
CALL OR WHATSAPP:689 45 44 70

2 Modeling Coal Combustion

In this simulation, you will simulate a coal combustion process.

You will:

- Start with the simulation you created in Simulation 1.
- Modify the flowsheet.
- Change the default stream class.
- Add the components needed for combustion.
- Specify the unit operation models.
- Define a Fortran block to control the decomposition of coal.
- Analyze the results.

Allow about 45 minutes to complete this simulation.

**CLASES PARTICULARES, TUTORÍAS TÉCNICAS ONLINE
LLAMA O ENVÍA WHATSAPP: 689 45 44 70**

- - -

**ONLINE PRIVATE LESSONS FOR SCIENCE STUDENTS
CALL OR WHATSAPP:689 45 44 70**

Coal Combustion Flowsheet

The process flow diagram, operating conditions and problem definition for this simulation are shown in the following figure. The feed to the furnace is the dried coal stream from Simulation 1. After combustion, the ash is separated from the gaseous combustion products.

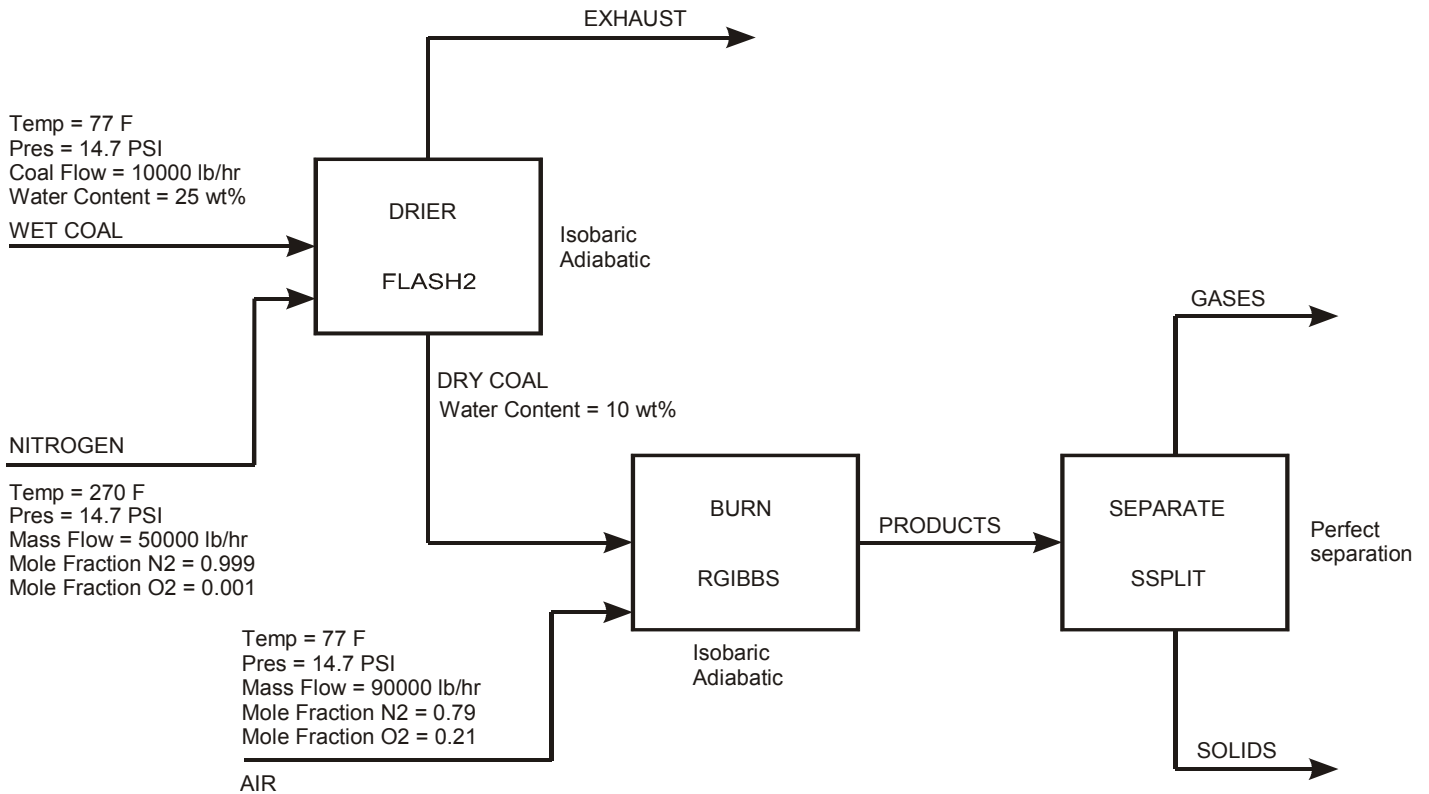

Starting Aspen Plus

- 1 From your desktop, select **Start** and then select **Programs**.
- 2 Select **AspenTech | Aspen Engineering Suite | Aspen Plus 2004.1 | Aspen Plus User Interface**.

The **Aspen Plus Startup** dialog box appears.

CLASES PARTICULARES, TUTORÍAS TÉCNICAS ONLINE
LLAMA O ENVÍA WHATSAPP: 689 45 44 70

ONLINE PRIVATE LESSONS FOR SCIENCE STUDENTS
CALL OR WHATSAPP:689 45 44 70

Opening an Existing Run

If You Completed the Simulation in Chapter 1 and Saved the Simulation

- 1 In the **Aspen Plus Startup** dialog box, select **Open an Existing Simulation**.
- 2 In the list, select Solid1.apw and click **OK**.

If Your Saved File Solid1.apw is Not Displayed

- 1 Double-click **More Files** in the list box.
The **Open** dialog box appears.
- 2 Navigate to the directory that contains your saved file Solid1.apw.
- 3 Select Solid1.apw in the list of files and click **Open**.



Note: If you did not create the simulation in Chapter 1, open the backup file solid1.bkp from the **Examples** folder.

To Access the Examples Folder

- 1 Double-click **More Files** in the list box.
The **Open** dialog box appears.
- 2 Click .

By default, the Favorites list contains five folders that are provided with Aspen Plus.

- 3 Double-click the **Examples** folder.
- 4 Select Solid1.bkp and click OK.



Note: If the **Connect to Engine** dialog box appears, see Chapter 5.

The
Cha

CLASES PARTICULARES, TUTORÍAS TÉCNICAS ONLINE
LLAMA O ENVÍA WHATSAPP: 689 45 44 70

- - -

ONLINE PRIVATE LESSONS FOR SCIENCE STUDENTS
CALL OR WHATSAPP:689 45 44 70

Saving a Run Under a New Name

Before creating a new run, create and save a copy of Solid1 with a new Run ID, Solid2. Then you can make modifications under this new Run ID.

- 1 From the **Aspen Plus** menu bar, select **File | Save As**.
- 2 In the **Save As** dialog box, choose the directory where you want to save the simulation.
- 3 In the **File name** field, enter *Solid2*.
- 4 In the **Save as type** field, click  and select Aspen Plus Documents (*.apw).
- 5 Click **Save** to save the simulation and continue.

Aspen Plus creates a new simulation model, Solid2, which is a copy of the base case simulation, Solid1.

Drawing the Graphical Simulation Flowsheet

Use the RGibbs model to simulate combustion of the dry coal. RGibbs models chemical equilibrium by minimizing Gibbs free energy. However, the Gibbs free energy of coal cannot be calculated because it is a nonconventional component.

Before feeding the dried coal to the RGibbs block, decompose the coal into its constituent elements. This is done in the RYield block, DECOMP. The heat of reaction associated with the decomposition of coal must be considered in the coal combustion. Use a heat stream to carry this heat of reaction from the RYield block to the RGibbs block.

Finally, separate the combustion gases from the ash using the Aspen Plus model SSplit for this separation.

Modify the flowsheet to include the additional unit operation models and streams, as shown below. (See *Getting Started Building and Running a Process Model*, Chapter 2, if you need to review how to create a graphical simulation flowsheet.) You will add three unit operation models (an RYield, an RGibbs, and an SSplit), five material streams, and one heat stream.

CLASES PARTICULARES, TUTORÍAS TÉCNICAS ONLINE
LLAMA O ENVÍA WHATSAPP: 689 45 44 70

- - -

ONLINE PRIVATE LESSONS FOR SCIENCE STUDENTS
CALL OR WHATSAPP:689 45 44 70

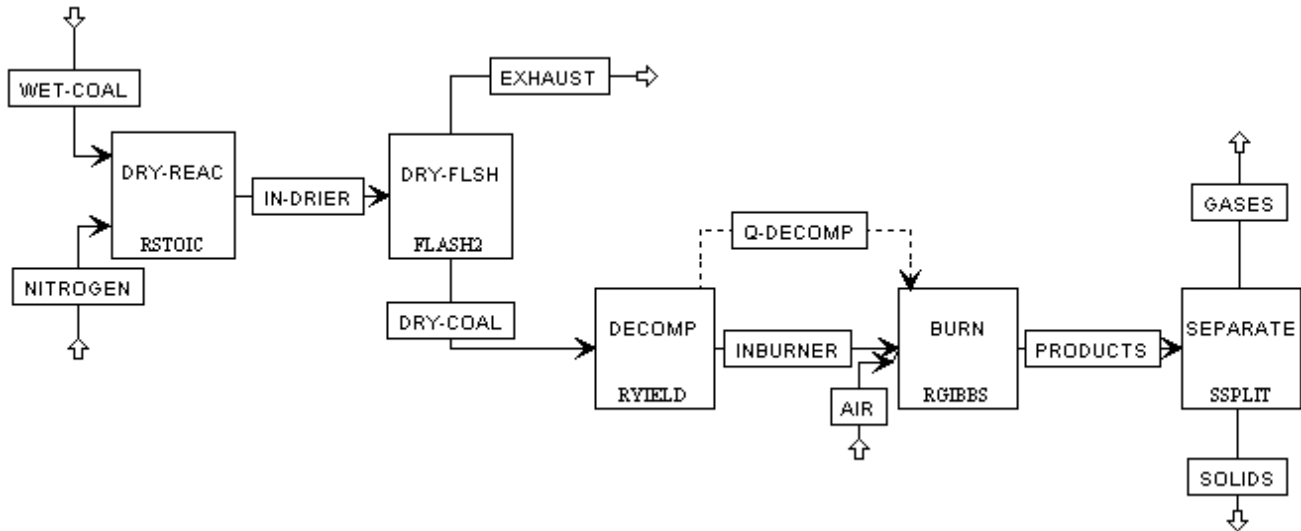

The simulation flowsheet appears different from the process diagram in the previous figure because the simulation flowsheet uses two unit operation models to simulate a single piece of equipment. An extra stream (INBURNER) is defined to connect the two simulation unit operation models. There is no real stream that corresponds with the simulation stream INBURNER.

Changing the Stream Class

Because the decomposition of coal forms carbon, you must use a stream class that includes conventional solids. Use the *MCINCPD* stream class. *MCINCPD* contains the following substreams:

- MIXED
- CIPSD
- NCPSD

To Change the Global Stream Class

- 1 From the **Data** menu, select **Setup**.

The **Setup | Specifications | Global** sheet appears.

- 2 In the **Stream Class** field, click and select *MCINCPD*.
- 3 In the **Title** field, enter: *Getting Started with Solids – Simulation 2*.

CLASES PARTICULARES, TUTORÍAS TÉCNICAS ONLINE
LLAMA O ENVÍA WHATSAPP: 689 45 44 70

ONLINE PRIVATE LESSONS FOR SCIENCE STUDENTS
CALL OR WHATSAPP:689 45 44 70

✓ Global ✓ Description Accounting ✓ Diagnostics

Title: Getting Started with Solids - Simulation 2

Units of measurement

Input data: ENG

Output results: ENG

Global settings

Run type: Flowsheet

Input mode: Steady-State

Stream class: MCINCPSD

Flow basis: Mass

Ambient pressure: 14.69595 psi

Ambient temp.: 50 F

Valid phases:

Free water: No

- 4 Close the **Data Browser** window.

CLASES PARTICULARES, TUTORÍAS TÉCNICAS ONLINE
LLAMA O ENVÍA WHATSAPP: 689 45 44 70

- - -

ONLINE PRIVATE LESSONS FOR SCIENCE STUDENTS
CALL OR WHATSAPP:689 45 44 70

Adding Components to the Model

Simulation 1 had four components: H₂O, N₂, O₂, and COAL. Add the components that are formed by decomposing and combusting coal.

- 1 From the **Data** menu, select **Components**.

The **Components | Specifications | Global** sheet appears.

- 2 Add the components listed below:

Component ID	Type	Component Name
NO2	Conventional	NITROGEN DIOXIDE
NO	Conventional	NITRIC OXIDE
S	Conventional	SULFUR
SO2	Conventional	SULFUR-DIOXIDE
SO3	Conventional	SULFUR-TRIOXIDE
H2	Conventional	HYDROGEN
CL2	Conventional	CHLORINE
HCL	Conventional	HYDROGEN-CHLORIDE
C	Solid	CARBON-GRAPHITE
CO	Conventional	CARBON-MONOXIDE
CO2	Conventional	CARBON-DIOXIDE
ASH	Nonconventional	



Note: You will need to type in the names for some components.

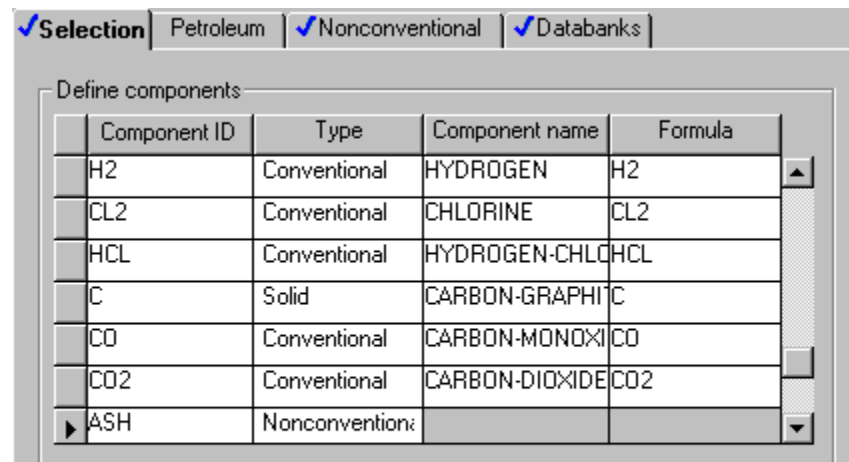

CLASES PARTICULARES, TUTORÍAS TÉCNICAS ONLINE
LLAMA O ENVÍA WHATSAPP: 689 45 44 70

ONLINE PRIVATE LESSONS FOR SCIENCE STUDENTS
CALL OR WHATSAPP:689 45 44 70



- 3 Click  to continue.

The **Properties | Advanced | NC Props | Property Methods** sheet appears.

Defining Properties

Use the **Properties | Advanced | NC Props | Property Methods** sheet to specify the models used to calculate the nonconventional solid properties. In Simulation 1, Aspen Plus estimates the heat of coal combustion based on its PROXANAL, ULTANAL, and SULFANAL. In this simulation, enter the heat of combustion directly.

Change the Heat of Combustion Method for Coal

- 1 In the **Component** field, click  and select *COAL*.
- 2 In the toolbar, click .
- 3 Click the HCOALGEN **Model name**.
- 4 Click the Coal Enthalpy link.
- 5 In the help window that appears, scroll down to the table **HCOALGEN Option Codes**.

The help screen indicates that the first option code defines how Aspen Plus calculates the heat of combustion. Aspen Plus has six methods for calculating the heat of combustion. Use the sixth method, *User input value*.

- 6 Close the help window.
- 7 Change the first HCOALGEN Option code value field from 1 to 6.

CLASES PARTICULARES, TUTORÍAS TÉCNICAS ONLINE
LLAMA O ENVÍA WHATSAPP: 689 45 44 70

- - -

ONLINE PRIVATE LESSONS FOR SCIENCE STUDENTS
CALL OR WHATSAPP:689 45 44 70

Property Methods

Component: **COAL**

Property models for the selected nonconventional component

	Model name	Option code value						
Enthalpy	HCOALGEN	6	1	1	1			
Density	DCOALIGT							

Required component attributes for the selected models

PROXANAL ULTANAL SULFANAL

Specify Methods for Calculating Ash Properties

You must also specify how Aspen Plus calculates the enthalpy and density of ASH.

- 8 In the **Component** field, click and select *ASH*.
- 9 In the **Model name** field for **Enthalpy**, click and select *HCOALGEN*.
The Option code value defaults of 1, 1, 1, and 1 are acceptable for ASH.
- 10 In the **Model name** field for **Density**, click and select *DCOALIGT*.

Property Methods

Component: **ASH**

Property models for the selected nonconventional component

	Model name	Option code value						
Enthalpy	HCOALGEN	1	1	1	1			
Density	DCOALIGT							

CLASES PARTICULARES, TUTORÍAS TÉCNICAS ONLINE
LLAMA O ENVÍA WHATSAPP: 689 45 44 70

ONLINE PRIVATE LESSONS FOR SCIENCE STUDENTS
CALL OR WHATSAPP:689 45 44 70

Specify the Heat of Combustion for Coal

You just specified that Aspen Plus will use a user-specified value for the heat of combustion of coal. Now you must specify that value.

- 11 From the Data Browser, select the **Properties | Parameters | Pure Component** folder.

The **Properties | Parameters | Pure Component** object manager appears.

- 12 Click **New**.

The **New Pure Component Parameters** dialog box appears.

The heat of combustion for coal is a Nonconventional type.

- 13 Select the **Nonconventional** option.

- 14 Delete the default name NC-1 and enter *HEAT* as the new name in the **Enter new name or accept default** field.

- 15 Click **OK**.

The **Properties | Parameters | Pure Component | HEAT | Input** sheet appears.

- 16 In the **Parameter** field, click  and select HCOMB.

Note that the prompt indicates that HCOMB is the heat of combustion on a dry basis. Use the following equation to convert the heat of combustion on a wet basis to a dry basis:

$$\text{HCOMB} = \text{Heat of Combustion (wet)} * \frac{100}{100 - \% \text{ Moisture}}$$

- 17 In the first line under the **Nonconventional component parameter** column, click  and select COAL.

- 18 In the parameter value field directly below COAL, enter the heat of combustion on a dry basis: 11700 Btu/lb.

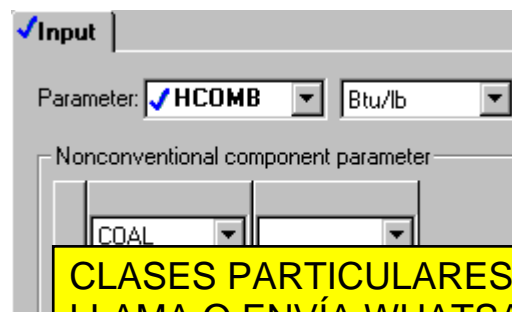

- 19 Click **OK**.

The

- 20 Click

CLASES PARTICULARES, TUTORÍAS TÉCNICAS ONLINE
LLAMA O ENVÍA WHATSAPP: 689 45 44 70

ONLINE PRIVATE LESSONS FOR SCIENCE STUDENTS
CALL OR WHATSAPP:689 45 44 70

Specifying the Air Stream

The **Streams | AIR | Input | Specifications** sheet appears. Aspen Plus requires two thermodynamic specifications, and enough information to calculate the flow rate of each component.

- 1 Enter the following thermodynamic specifications for the MIXED substream:

Temperature 77.0 F

Pressure 14.7 psi

- 2 In the Composition box, click and select Mole-Frac.

- 3 Enter the following mole fractions:

N2 0.79

O2 0.21

- 4 Enter a total mass flow of 90000 lb/hr.

Substream name: MIXED

State variables:

Temperature: 77 F

Pressure: 14.7 psi

Total flow: 90000 lb/hr

Composition:

Mole-Frac

Component	Value
H2O	
N2	0.79
O2	0.21
NO2	
NO	
S	
SO2	

Total: 1

- 5 Click to continue.

Specifying Unit Operation Models

The BL
RGibbs
calcula
Gibbs
reactio

CLASES PARTICULARES, TUTORÍAS TÉCNICAS ONLINE
LLAMA O ENVÍA WHATSAPP: 689 45 44 70

ONLINE PRIVATE LESSONS FOR SCIENCE STUDENTS
CALL OR WHATSAPP:689 45 44 70

Specify the RGibbs Reactor Model

On the **BURN | Setup | Specifications** sheet, enter your thermodynamic specifications. This reactor will be at atmospheric pressure.

- 1 In the **Pressure** field, enter 14.7 psi.

The heat duty for this reactor is specified by the heat stream Q-DECOMP.

- 2 In the Calculation options box, select **Phase equilibrium & chemical equilibrium**.

- 3 Select the **Products** tab.

The **BURN | Setup | Products** sheet appears. On this sheet, enter the list of products that may exist at equilibrium.

By default, RGibbs assumes that all of the components that are listed on the **Components | Specifications | Selection** sheet are potential products in the vapor phase or the liquid phase. This default is not appropriate for this simulation, since any carbon that remains after combustion would be solid.

- 4 Select **Identify possible products**.

The **Products** list appears.

For this simulation, all components are potential MIXED substream products, except for carbon, which is a solid product. Carbon must be assigned a phase of Pure Solid. This means that any carbon that forms will be present as a pure, solid phase, not present as a solid solution or alloy.

- 5 In the products list, enter the component species and phases shown below: (Be sure to change the Phase for C to Pure Solid.)

Component	Phase	Component	Phase
H2O	Mixed	SO3	Mixed
N2	Mixed	H2	Mixed
O2	Mixed	CL2	Mixed
NO2	Mixed	HCL	Mixed
NO	Mixed	C	Pure Solid
S	Mixed	CO	Mixed
SO2	Mixed	CO2	Mixed

CLASES PARTICULARES, TUTORÍAS TÉCNICAS ONLINE
LLAMA O ENVÍA WHATSAPP: 689 45 44 70

- - -

ONLINE PRIVATE LESSONS FOR SCIENCE STUDENTS
CALL OR WHATSAPP:689 45 44 70

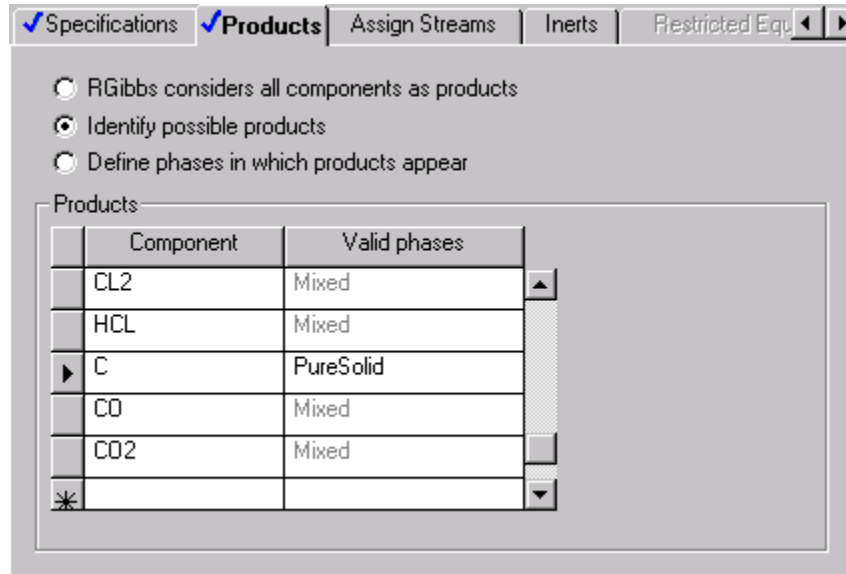

6 Click  to continue.

Specify the RYield Reactor Model

The **DECOMP | Setup | Specifications** sheet appears. RYield is used to simulate a reactor with a known yield, and does not require reaction stoichiometry and kinetics.

7 On the **DECOMP | Setup | Specifications** sheet, enter the pressure and temperature:

Pressure 14.7 psi

Temperature 77.0 F

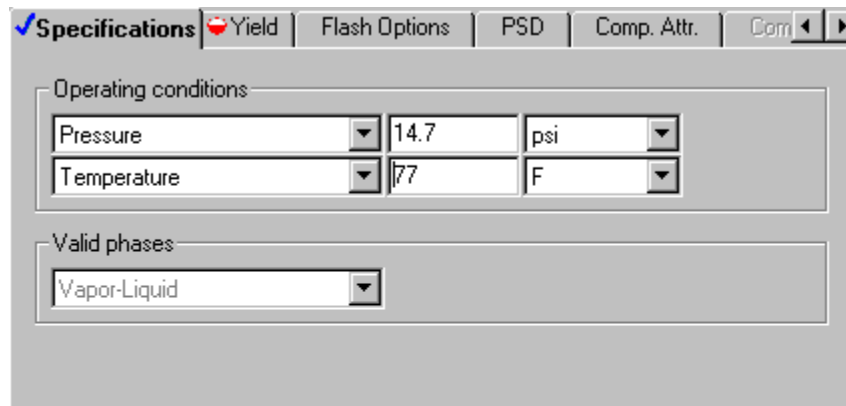

8 Click

CLASES PARTICULARES, TUTORÍAS TÉCNICAS ONLINE
LLAMA O ENVÍA WHATSAPP: 689 45 44 70

ONLINE PRIVATE LESSONS FOR SCIENCE STUDENTS
CALL OR WHATSAPP:689 45 44 70

The **Yield** sheet appears.

For this simulation, the yield distribution you enter on this sheet is not the true yield distribution. Use a Calculator block to calculate the actual yield distribution from the component attributes for coal in the feed stream to the RYield model (stream DRY-COAL).

- 9 Enter the component yields as follows:

Component	Basis	Yield
H2O	Mass	0.2
ASH	Mass	0.2
C (CIPSD)	Mass	0.1
H2	Mass	0.1
N2	Mass	0.1
CL2	Mass	0.1
S	Mass	0.1
O2	Mass	0.1

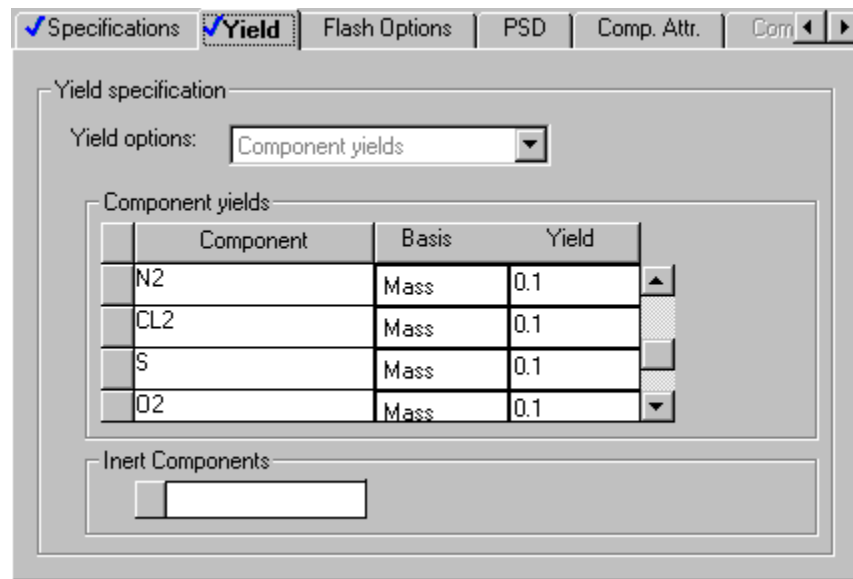

In addition to the MIXED substream products, this RYield block forms carbon in the CIPSD substream and ash in the NCPSD substream. To fully specify the yield, specify the particle size distributions of the CIPSD and NCPSD substream and the component attributes of the ash that is formed.

Specify the Particle Size Distributions

- 1 Click the **PSD** tab.

The
2 In

CLASES PARTICULARES, TUTORÍAS TÉCNICAS ONLINE
LLAMA O ENVÍA WHATSAPP: 689 45 44 70

ONLINE PRIVATE LESSONS FOR SCIENCE STUDENTS
CALL OR WHATSAPP:689 45 44 70

- 3 Specify the weight fractions for the last four intervals of the particle size distribution for the carbon formed in the CIPSD substream:

Interval	Weight Fraction
7	0.1
8	0.2
9	0.3
10	0.4

It is not necessary to enter zero for intervals 1 through 6.

Substream ID: CIPSD

Particle size distribution

PSD ID: Units:

Interval	Lower limit	Upper limit	Weight fraction
5	80	100	
6	100	120	
7	120	140	0.1
8	140	160	0.2
9	160	180	0.3
10	180	200	0.4

You must also define the particle size distribution for the NCPSD substream.

- 4 In the **Substream ID** field, click and select *NCPSD*.
- 5 Enter the same weight fractions for the particle size distribution for the NCPSD substream that you entered for the CIPSD substream above.

Specify the Component Attributes for Ash

- 6 Click the **Comp. Attr.** tab.

The attributes PROXANAL, ULTANAL, and SULFANAL are required for RYield to calculate the enthalpy and density of ash.

- 7 In
- 8 In
- 9 In

CLASES PARTICULARES, TUTORÍAS TÉCNICAS ONLINE
 LLAMA O ENVÍA WHATSAPP: 689 45 44 70

 ONLINE PRIVATE LESSONS FOR SCIENCE STUDENTS
 CALL OR WHATSAPP:689 45 44 70

10 For the attribute PROXANAL, enter these values:

Element	Value
Moisture	0
FC	0
VM	0
Ash	100

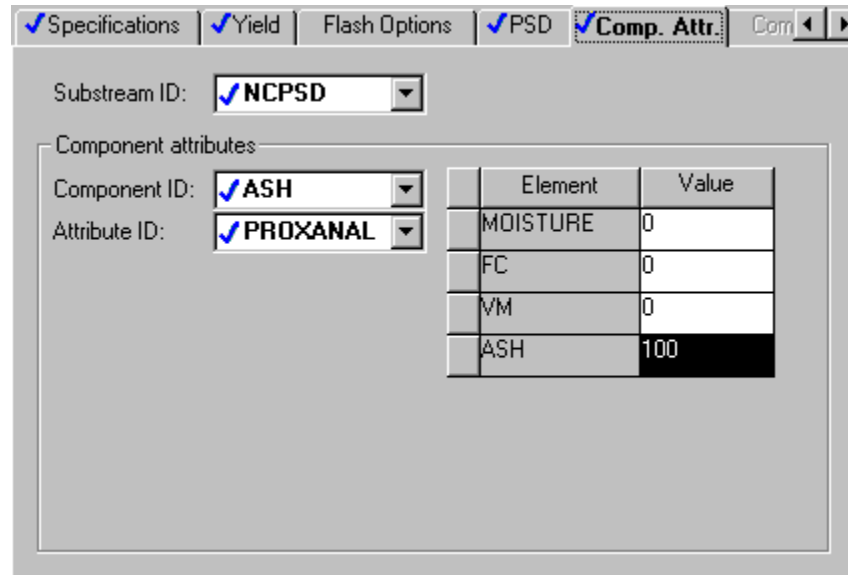

Substream ID: NCPD

Component attributes:

Component ID: ASH

Attribute ID: PROXANAL

Element	Value
MOISTURE	0
FC	0
VM	0
ASH	100

11 In the **Attribute ID** field, click and select *ULTANAL*.

12 For the attribute ULTANAL, enter these values:

Element	Value
Ash	100
Carbon	0
Hydrogen	0
Nitrogen	0
Chlorine	0
Sulfur	0
Oxygen	0

13 In the **Attribute ID** field, click and select *SULFANAL*.

14 For the attribute SULFANAL, enter these values:

Element	Value
Pyritic	0

Su
Or

15 Clic

CLASES PARTICULARES, TUTORÍAS TÉCNICAS ONLINE
LLAMA O ENVÍA WHATSAPP: 689 45 44 70

ONLINE PRIVATE LESSONS FOR SCIENCE STUDENTS
CALL OR WHATSAPP:689 45 44 70

Specify the Splits for the SSplit Block

The **SEPARATE | Input | Specifications** sheet appears. SSplit mixes all of its feed streams, then splits the resulting mixture into two or more streams according to substream specifications. SSplit operates on substreams the same way a Sep block operates on components.

In this simulation, the SSplit block provides perfect separation between the gaseous products of combustion (MIXED substream) and the solid products of combustion (CIPSD and NCPSD substreams).

16 Enter the following split fraction values for the GASES outlet stream:

Substream Name	Value
MIXED	1.0
CIPSD	0.0
NCPSD	0.0

Substream Name	Specification	Basis	Value	Units
MIXED	Split fraction		1	%
CIPSD	Split fraction		0	%
NCPSD	Split fraction		0	%

17 Close the **Data Browser** window.

Defining a Calculator Block

You have completed enough specifications to run the simulation. However, the yields you specified in the RYield block were only temporary placeholders. You could directly enter the correct yields on the **RYield | Setup | Yield** sheet. However, by defining a Calculator block to calculate the yields based on the different substreams, you can avoid the need to manually enter the yields on the RYield sheet.

CLASES PARTICULARES, TUTORÍAS TÉCNICAS ONLINE
LLAMA O ENVÍA WHATSAPP: 689 45 44 70

ONLINE PRIVATE LESSONS FOR SCIENCE STUDENTS
CALL OR WHATSAPP:689 45 44 70

Create the Calculator Block

- 1 From the Aspen Plus menu bar, select **Data | Flowsheeting Options | Calculator**.

The **Calculator** object manager appears.

- 2 Click **New** to create a new Calculator block.

The **Create new ID** dialog box appears with an automatically generated ID, C-1.

- 3 In the **Create new ID** dialog box, enter *COMBUST* as the ID and click **OK**.

Define the Calculator Variables

The **Calculator | COMBUST | Input | Define** sheet appears.

Use this sheet to access the flowsheet variables you want to use in the Fortran block. In the simulation in Chapter 1, you accessed individual elements of component attributes. You can also access component attributes as a vector. In this simulation, access the ultimate analysis of coal in stream DRY-COAL as a component attribute vector. Also define variables to access the moisture content of coal and the yield of each component in the DECOMP block.

- 4 Create and define the following two variables:

Variable Name	Type	Stream	Substream	Component	Attribute	Element
ULT	Compattr-Vec	DRY-COAL	NCPSD	COAL	ULTANAL	
WATER	Compattr-Var	DRY-COAL	NCPSD	COAL	PROXANAL	1

- 5 Also define the following eight mass yield variables.

Variable Name		ID1	ID2
H2O	Type <i>Block-Var</i> Block <i>DECOMP</i> Variable <i>MASS-YIELD</i> for all eight variables.	H2O	MIXED
ASH		ASH	NCPSD
CARB		C	CIPSD
H2		H2	MIXED
N2		N2	MIXED
CL2		CL2	MIXED
SULF		S	MIXED
O2		O2	MIXED

CLASES PARTICULARES, TUTORÍAS TÉCNICAS ONLINE
 LLAMA O ENVÍA WHATSAPP: 689 45 44 70

- - -

ONLINE PRIVATE LESSONS FOR SCIENCE STUDENTS
 CALL OR WHATSAPP:689 45 44 70

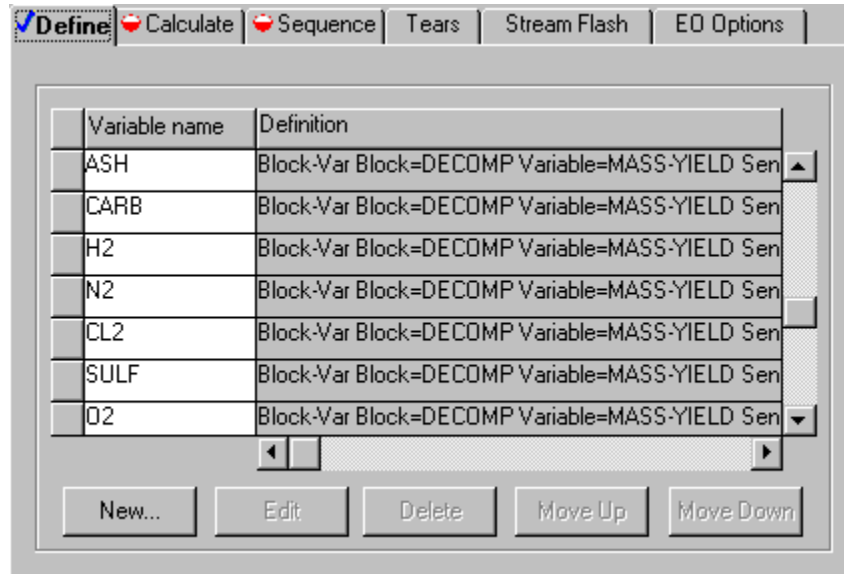

6 Click the **Calculate** tab.

Specify the Calculations to be Performed

The **Calculator | COMBUST | Input | Calculate** sheet appears.

ULTANAL is defined as the ultimate analysis on a dry basis. The variable WATER, defined as the percent H₂O in the PROXANAL for coal, is used to convert the ultimate analysis to a wet basis. The remaining eight variables (H₂O through O₂) are defined as the individual component yields of various species in the RYield block. ULT and WATER can then be used to calculate the yield of the individual species in the RYield block.

7 Enter the following Fortran statements:

```

C      FACT IS THE FACTOR TO CONVERT THE ULTIMATE ANALYSIS TO
C      A WET BASIS.
      FACT = (100 - WATER) / 100
      H2O  = WATER  / 100
      ASH  = ULT(1) / 100 * FACT
      CARB = ULT(2) / 100 * FACT
      H2   = ULT(3) / 100 * FACT



```

CLASES PARTICULARES, TUTORÍAS TÉCNICAS ONLINE
LLAMA O ENVÍA WHATSAPP: 689 45 44 70

8 Click **ONLINE PRIVATE LESSONS FOR SCIENCE STUDENTS
CALL OR WHATSAPP:689 45 44 70**

Specify When the Calculator Block Should be Run

The **Calculator | COMBUST | Input | Sequence** sheet appears. Since this Calculator block sets values in block DECOMP, the Calculator block must execute before DECOMP.

- 9 In the **Execute** field, click  and select *Before*.
- 10 In the **Block type** field, click  and select *Unit operation*.
- 11 In the **Block name** field, click  and select *DECOMP*.

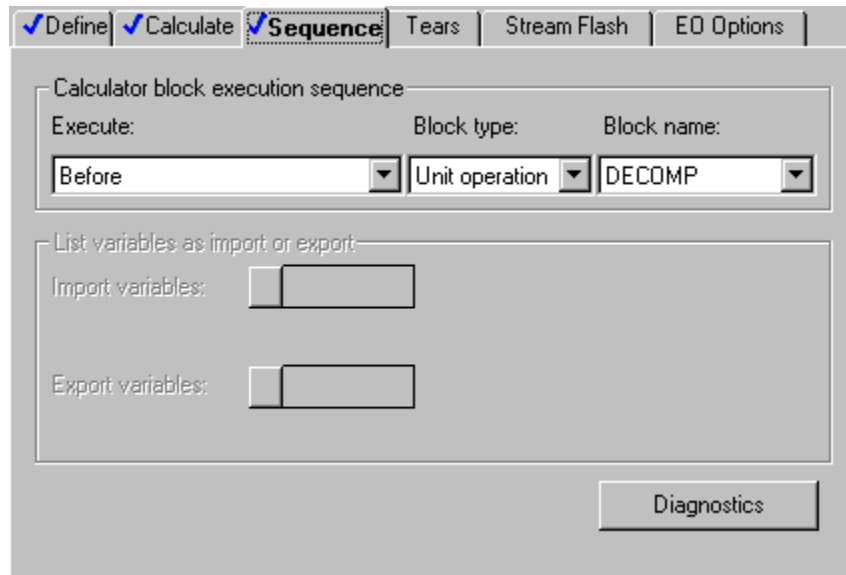

- 12 Close the Data Browser window.
- 13 Click  to continue.

Running the Simulation

- 1 In the **Required Input Complete** dialog box, click **OK** to run the simulation.

The **Control Panel** window appears, allowing you to monitor and interact with the Aspen Plus simulation calculations.

Aspen Plus...
wa...
out...
Aspen...
une...
ign...
inte...

CLASES PARTICULARES, TUTORÍAS TÉCNICAS ONLINE
LLAMA O ENVÍA WHATSAPP: 689 45 44 70

ONLINE PRIVATE LESSONS FOR SCIENCE STUDENTS
CALL OR WHATSAPP:689 45 44 70

As Aspen Plus performs the analysis, you will see status messages displayed in the Control Panel.

No further warnings are generated.

When the calculations finish, the message *Results Available* appears in the status area at the bottom right of the main window.

- 2 When the *Simulation Run Completed* message appears in the status bar, close the **Control Panel** window.
- 3 Examine the results of your simulation.

Examining Results

View the Stream Results

- 1 From the toolbar, click .

The **Results Summary | Run Status | Summary** sheet appears, indicating that the simulation completed normally.

- 2 Click  to access the next results sheet.

The **Results Summary | Streams | Material** sheet appears.

- 3 Review the results on this sheet. Use the horizontal scrollbar to review results that are off the screen.

- 4 In the Display field, click  and select **Streams**.

- 5 At the top of each column, and click  and select *INBURNER*, *AIR*, *PRODUCTS*, *GASES*, and *SOLIDS*.

Results are filled in for each stream as it is specified.

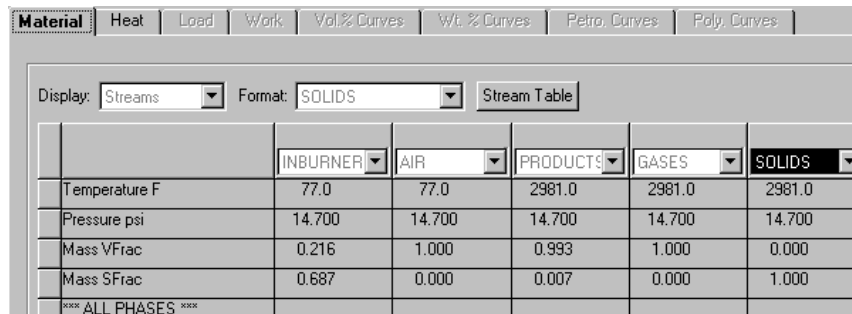

	INBURNER	AIR	PRODUCTS	GASES	SOLIDS
Temperature F	77.0	77.0	2981.0	2981.0	2981.0
Pressure psi	14.700	14.700	14.700	14.700	14.700
Mass VFrac	0.216	1.000	0.993	1.000	0.000
Mass SFrac	0.687	0.000	0.007	0.000	1.000
*** ALL PHASES ***					

- 6 Review the results. The results are displayed in the table below.

CLASES PARTICULARES, TUTORÍAS TÉCNICAS ONLINE
LLAMA O ENVÍA WHATSAPP: 689 45 44 70

ONLINE PRIVATE LESSONS FOR SCIENCE STUDENTS
CALL OR WHATSAPP:689 45 44 70

Stream PRODUCTS is the outlet of the RGibbs equilibrium reactor that models the combustion process. Since oxygen appears in stream PRODUCTS, the combustion process has excess air. An examination of stream PRODUCTS enables you to determine the most stable products for each atom in the combustion process:

- SO₂ is favored over SO₃ and S.
- N₂ is favored over NO and NO₂.
- CO₂ is favored over CO and C (solid).
- HCL is favored over CL₂.

7 Click  to access the next results sheet.

The **Results Summary | Streams | Heat** sheet appears.

This sheet displays the results for heat streams. Examine the results for Q-DECOMP. The heating value of Q-DECOMP represents the enthalpy change in breaking down the coal in stream DRY-COAL into its constituent elements.

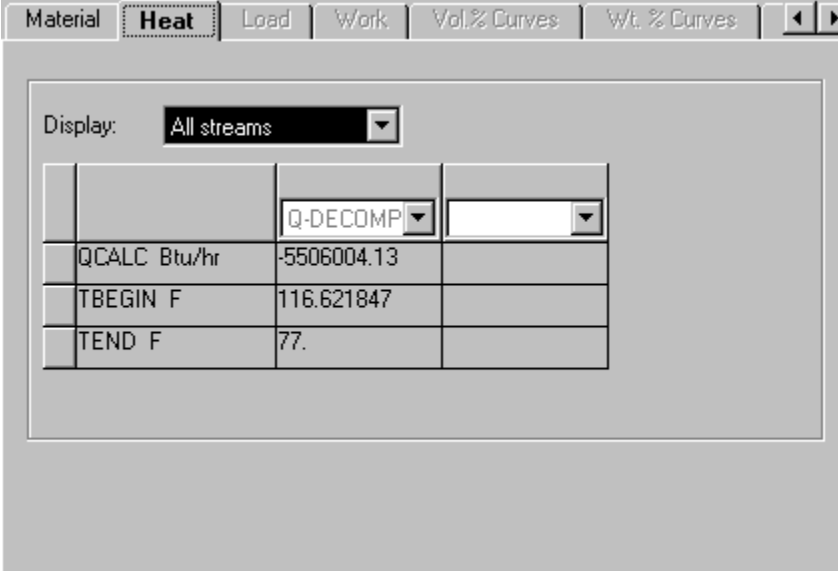

Material		Heat	Load	Work	Vol.% Curves	Wt. % Curves
Display: All streams						
		Q-DECOMP				
	QCALC Btu/hr	-5506004.13				
	TBEGIN F	116.621847				
	TEND F	77.				

8 Close the **Data Browser** window.

View the Block Results

You do not need to view the results for Blocks DRY-REAC and DRY-FLSH, since they are unchanged from Simulation 1. View the results for blocks DECOMP, BURN, and SEPARATE.

9 In
10 Right-click
The
the

**CLASES PARTICULARES, TUTORÍAS TÉCNICAS ONLINE
LLAMA O ENVÍA WHATSAPP: 689 45 44 70**

**ONLINE PRIVATE LESSONS FOR SCIENCE STUDENTS
CALL OR WHATSAPP:689 45 44 70**

Summary	Balance	Phase Equilibrium	Weight distribution	Psi
RYield results				
Outlet temperature:	77	F		
Outlet pressure:	14.7	psi		
Heat duty:	5506004.13	Btu/hr		
Net heat duty:	5506004.13	Btu/hr		
Vapor fraction:	0.84137063			
1st liquid / Total liquid:	1			

- 11 Click  to access the next results sheet.

The **DECOMP | Results | Balance** sheet appears. Use this sheet to report the mass and energy balance for the block. Because RYield has a net reaction from nonconventional components to conventional components, the mass balance for both conventional components and nonconventional components is out of balance. However, the total mass balance is in balance.

- 12 Click  to access the next results sheet.

The **DECOMP | Results | Phase Equilibrium** sheet appears. This sheet indicates that the liquid from the RYield block is a solution of water and sulfur. In actuality, the sulfur would form a solid at this temperature. However, this fact does not matter for this simulation, because the stream (coal broken down into its constituents) does not exist in a real combustion process. This stream exists only as a mathematical construct to simplify the specification of the combustion process.

- 13 In the **Data Browser** menu tree, expand the list of forms for the **BURN** block and select **Results**.

The **BURN | Results | Summary** sheet appears. This sheet reports the outlet thermodynamic conditions of the RGibbs block. The outlet temperature is the adiabatic flame temperature of the coal with a fixed amount of excess air.

Summary	Balance	Phase Composition	Pure Solids	Atom Matrix
RGibbs results				
Outlet temperature:	2980.97915	F		
Outlet pressure:	14.7	psi		
Heat duty:	5506004.13	Btu/hr		

CLASES PARTICULARES, TUTORÍAS TÉCNICAS ONLINE
LLAMA O ENVÍA WHATSAPP: 689 45 44 70

ONLINE PRIVATE LESSONS FOR SCIENCE STUDENTS
CALL OR WHATSAPP:689 45 44 70

14 Click  to access the next results sheet.

The **BURN | Results | Balance** sheet appears.

15 Click  to access the next results sheet.

The **BURN | Results | Phase Composition** sheet appears.

This sheet displays the mole fraction of components in all phases. In this case, there is only a vapor phase.

16 Click  to access the next results sheet.

The **BURN | Results | Atom Matrix** sheet appears. This sheet reports the atomic composition for each component.

17 In the **Data Browser** menu tree, expand the list of forms for the **SEPARATE** block and select **Results**.

The **SEPARATE | Results | Summary** sheet appears. This sheet reports the split fraction for each substream.

18 Click  to access the next results sheet.

The **SEPARATE | Results | Balance** sheet appears.

Exiting Aspen Plus

When finished working with this model, exit Aspen Plus as follows:

1 From the **Aspen Plus** menu bar, select **File | Exit**.

The **Aspen Plus** dialog box appears.

2 Click **Yes** to save the simulation.

Aspen Plus saves the simulation as the Aspen Plus Document file, Solid2.apw, in your default working directory (displayed in the **Save in** field).



Note: The chapter 3 simulation uses this run as the starting point.

CLASES PARTICULARES, TUTORÍAS TÉCNICAS ONLINE
LLAMA O ENVÍA WHATSAPP: 689 45 44 70

- - -

ONLINE PRIVATE LESSONS FOR SCIENCE STUDENTS
CALL OR WHATSAPP:689 45 44 70

3 Modeling Gas-Solid Separators

In this simulation, start with the simulation developed in Simulation 2, and add a rigorous gas-solid separation train to separate the ash from the combustion gases.

You will:

- Modify the default particle size intervals.
- Use solids-handling unit operation models.

Allow about 20 minutes to do this simulation.

**CLASES PARTICULARES, TUTORÍAS TÉCNICAS ONLINE
LLAMA O ENVÍA WHATSAPP: 689 45 44 70**

**ONLINE PRIVATE LESSONS FOR SCIENCE STUDENTS
CALL OR WHATSAPP:689 45 44 70**

Gas-Solid Separation Flowsheet

The process flow diagram and operating conditions for this simulation are shown in the following figure.

The combustion products from Simulation 2 are fed to a rigorous gas-solid separation train. Once the products are cooled, solids are removed from the gases by a cyclone, a fabric filter, and an electrostatic precipitator in series.

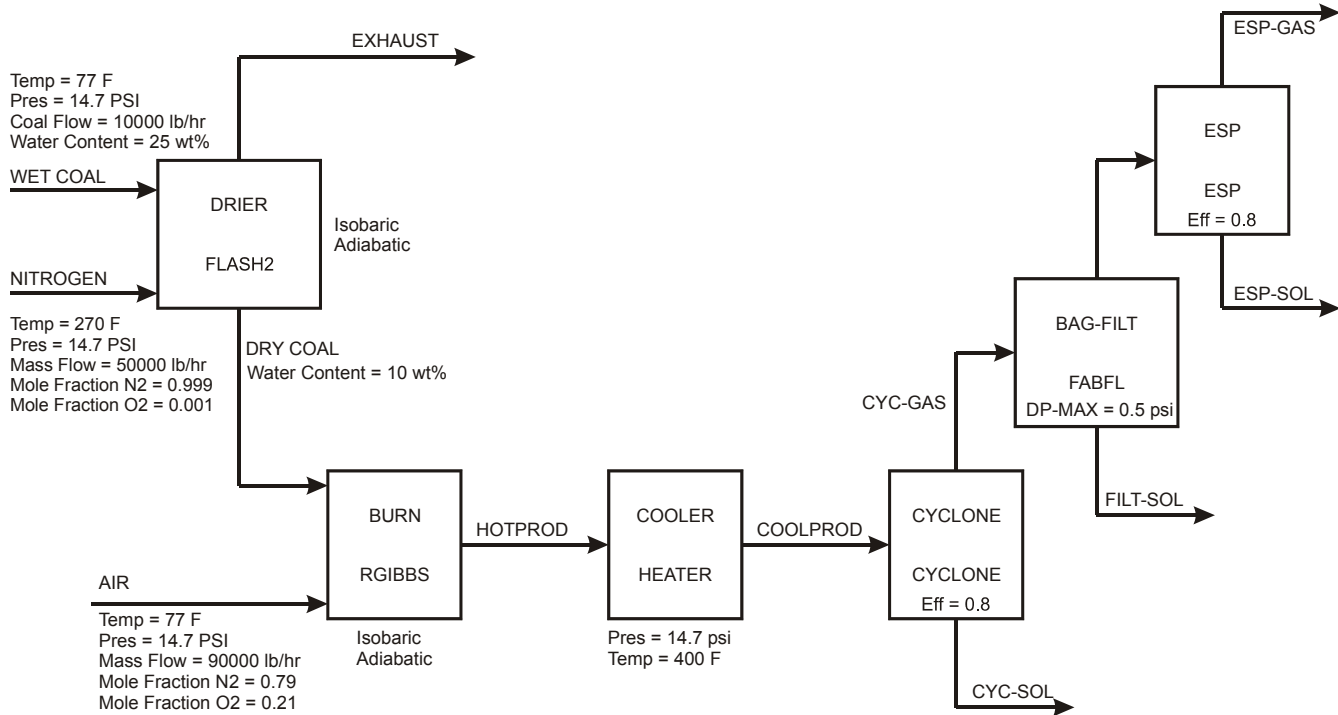

Starting Aspen Plus

- 1 From your desktop, select **Start** and then select **Programs**.
- 2 Select **AspenTech | Aspen Engineering Suite | Aspen Plus 2004.1 | Aspen Plus User Interface**.

The **Aspen Plus Startup** dialog box appears.

CLASES PARTICULARES, TUTORÍAS TÉCNICAS ONLINE
LLAMA O ENVÍA WHATSAPP: 689 45 44 70

ONLINE PRIVATE LESSONS FOR SCIENCE STUDENTS
CALL OR WHATSAPP:689 45 44 70

Opening an Existing Run

If You Completed the Simulation in Chapter 2 and Saved the Simulation

- 1 In the **Aspen Plus Startup** dialog box, select the radio button next to the Open an Existing Simulation field.
- 2 In the list, select Solid2.apw and click **OK**.

If Your Saved File Solid2.apw is Not Displayed

- 1 Double-click **More Files** in the list box.
The **Open** dialog box appears.
- 2 Navigate to the directory that contains your saved file Solid2.apw.
- 3 Select Solid2.apw in the list of files and click **Open**.
The **Aspen Plus** window appears.



Note: If you did not create the simulation in Chapter 2, open the backup file Solid2.bkp in the **Examples** folder.

To Access the Examples Folder

- 1 Double-click **More Files** in the list box.
The **Open** dialog box appears.
- 2 Click .
- 3 Double-click the **Examples** folder.
- 4 Select Solid2.bkp and click **OK**.



Note: If the **Connect to Engine** dialog box appears, see Chapter 5.

CLASES PARTICULARES, TUTORÍAS TÉCNICAS ONLINE
LLAMA O ENVÍA WHATSAPP: 689 45 44 70

- - -

ONLINE PRIVATE LESSONS FOR SCIENCE STUDENTS
CALL OR WHATSAPP:689 45 44 70

The process flowsheet from Chapter 2 appears:

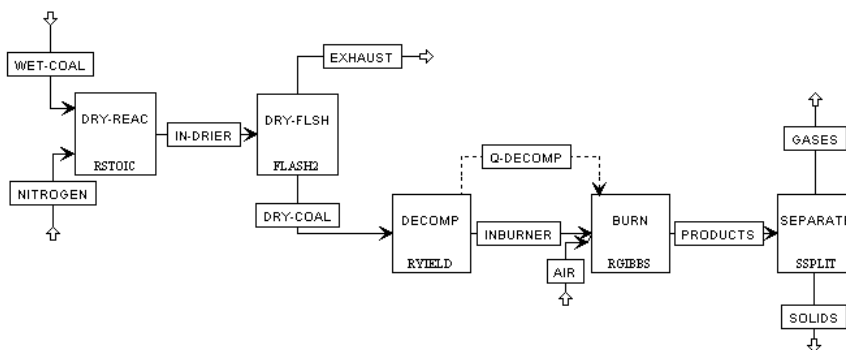

Saving a Run Under a New Name

Before creating a new run, create and save a copy of Solid2 with a new Run ID, Solid3. Then you can make modifications under this new Run ID.

- 1 From the **Aspen Plus** menu bar, select **File | Save As**.
- 2 In the **Save As** dialog box, choose the directory where you want to save the simulation.
- 3 In the **File name** field, enter Solid3.
- 4 In the **Save as type** field, click and select *Aspen Plus Documents (*.apw)*.
- 5 Click **Save** to save the simulation and continue.

Aspen Plus creates a new simulation model, Solid3, which is a copy of the base case simulation, Solid2.

Drawing the Graphical Simulation Flowsheet

In the previous simulation, the SSplit block after combustion assumed perfect separation of the ash from the combustion gases. In the simulation in this chapter, replace the SSplit block with the following blocks in series: Heater, Cyclone, FabFI, and ESP.

- 1 Click **CLASES PARTICULARES, TUTORÍAS TÉCNICAS ONLINE**
- 2 Pre **LLAMA O ENVÍA WHATSAPP: 689 45 44 70**
- 3 In **---**
- 4 Dra **ONLINE PRIVATE LESSONS FOR SCIENCE STUDENTS**
Ru **CALL OR WHATSAPP:689 45 44 70**

graphical simulation flowsheet.) Change the name of the product stream of the RGibbs block and connect it to the new Heater block.

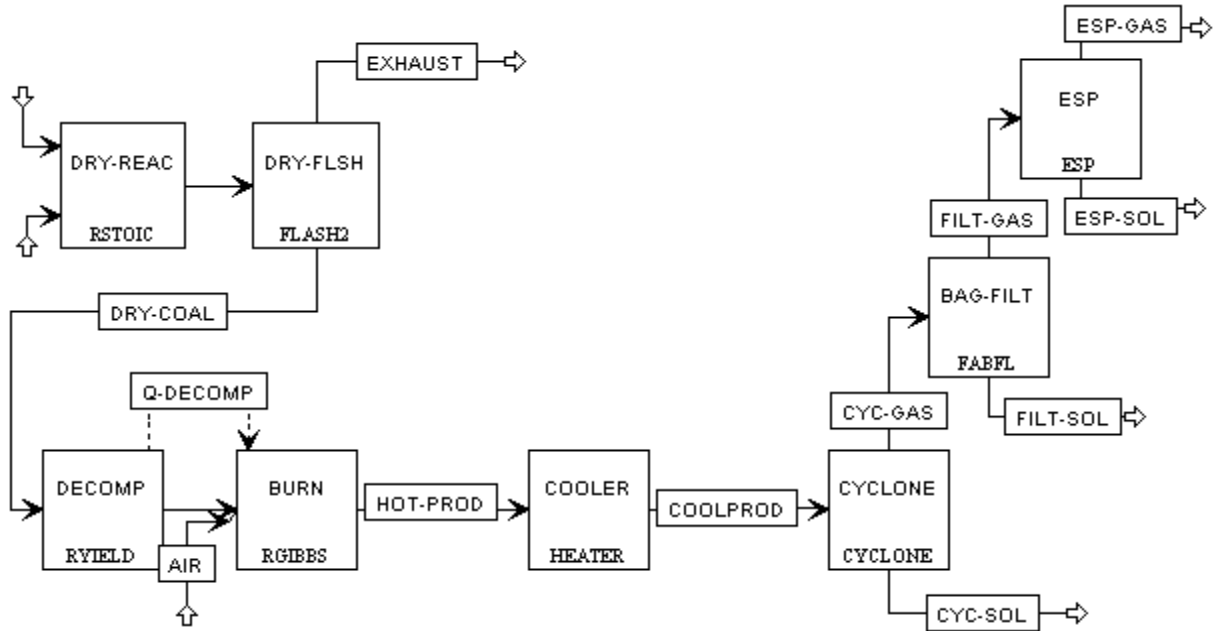

Changing the Default Particle Size Distribution

To Update the Title for This Simulation

- 1 From the **Data** menu, select **Setup**.

The **Setup | Specifications | Global** sheet appears.

- 2 Enter the new title *Getting Started with Solids—Simulation 3*.

Next, modify the system defaults for the size intervals in a particle size distribution:

To Modify the Particle Size Distribution Intervals

- 3 From the Data Browser, expand the **Substreams** folder.

4 From the Data Browser, select the **CLASES PARTICULARES, TUTORÍAS TÉCNICAS ONLINE** stream. The **LLAMA O ENVÍA WHATSAPP: 689 45 44 70** dialog box appears.

- 5 In the **CLASES PARTICULARES, TUTORÍAS TÉCNICAS ONLINE** dialog box, click **OK**.

ONLINE PRIVATE LESSONS FOR SCIENCE STUDENTS
CALL OR WHATSAPP:689 45 44 70

- 6 Enter the following six intervals to describe the particle size distribution. Each **Upper** value is automatically copied to the next **Lower** value.

Interval	Lower [mu]	Upper [mu]
1	0	1
2	1	2
3	2	4
4	4	8
5	8	16
6	16	32

Updating Particle Size Distributions Previously Entered

Changing the intervals of the particle size distribution (PSD) modifies the particle size distributions you entered in the previous simulations.

- 1 In the Data Browser menu tree, select the **Streams | WET-COAL | Input** form.
- 2 Click the **PSD** tab.

The **Streams | WET-COAL | Input | PSD** sheet appears.

The original PSD for this stream used size intervals 7 through 10. Since you just deleted intervals 7 through 10, the PSD is now empty and you

mu
any
is r

**CLASES PARTICULARES, TUTORÍAS TÉCNICAS ONLINE
LLAMA O ENVÍA WHATSAPP: 689 45 44 70**

- 3 Ent...

You
RYi

**ONLINE PRIVATE LESSONS FOR SCIENCE STUDENTS
CALL OR WHATSAPP:689 45 44 70**

- 4 In the Data Browser menu tree, select the **Blocks | DECOMP | Setup** form.
- 5 Select the **PSD** tab.
The **Blocks | DECOMP | Setup | PSD** sheet appears.
- 6 In the **Substream** field, click and select *CIPSD*.
- 7 Enter the following values of **Weight Fraction** for the CIPSD substream. (These particle size distributions are chosen for illustrative purposes only and are not meant to be typical of an industrial application.)

Interval	Weight Fraction
1	0.1
2	0.1
3	0.2
4	0.2
5	0.2
6	0.2

Interval	Lower limit	Upper limit	Weight fraction
1	0	1	0.1
2	1	2	0.1
3	2	4	0.2
4	4	8	0.2
5	8	16	0.2
6	16	32	0.2

- 8 In the **Substream** field, click and select *NCPSD*.
- 9 Enter the same weight fractions for the particle size distribution for the NCPSD substream that you entered for the CIPSD substream above.
- 10 Click to continue.





CLASES PARTICULARES, TUTORÍAS TÉCNICAS ONLINE
LLAMA O ENVÍA WHATSAPP: 689 45 44 70

ONLINE PRIVATE LESSONS FOR SCIENCE STUDENTS
CALL OR WHATSAPP:689 45 44 70

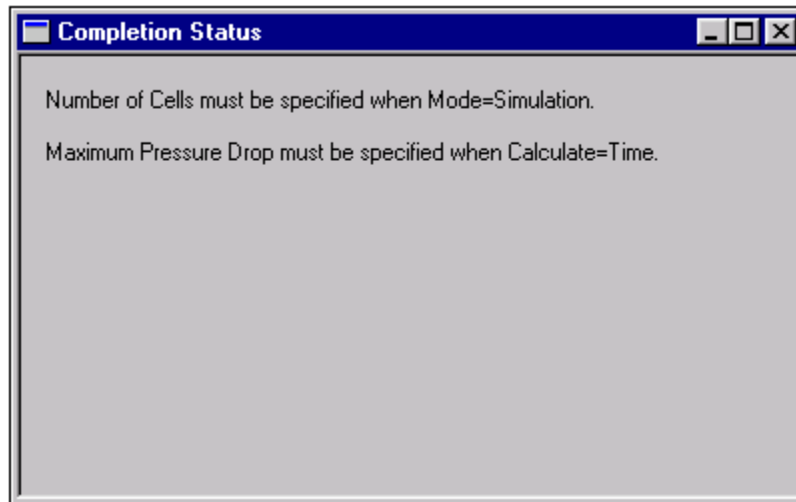
Sp
Blo
The BA

- 1 Click  to find out what must be specified on this sheet.



- 2 Click  to close the **Completion Status** window.
Use the design mode of the fabric filter model (FabFI), not the simulation mode. Simulation mode determines the capacity of an existing piece of equipment. Design mode determines the size of a new piece of equipment with a given capacity.
- 3 In the **Mode** field, click  and select *Design*.
- 4 Click  to determine what input is required for the FabFI model in design mode.
In design mode, FabFI requires a specification for the maximum pressure drop.
- 5 Click  to close the **Completion Status** window.
- 6 In the **Maximum pressure drop** field, enter a value of 0.5 psi.

CLASES PARTICULARES, TUTORÍAS TÉCNICAS ONLINE
LLAMA O ENVÍA WHATSAPP: 689 45 44 70

- - -

ONLINE PRIVATE LESSONS FOR SCIENCE STUDENTS
CALL OR WHATSAPP:689 45 44 70

Specifications	Operation Options	Efficiency
Calculation options		
Mode:	Design	Calculate: Time
Dust resistance coefficient:	60000	Pa/(kg/m ²)/(m/s)
Baghouse characteristics		
Number of cells:		Filtering area: 15.93059 sqft
No. of cleaned cells:	1	Diameter: 0.5052493 ft
No. of bags per cell:	78	Pressure drop: 0.0362594 psi
Filter operating conditions		
Maximum pressure drop:	0.5	psi

7 Click  to continue.

The **COOLER | Input | Specifications** sheet appears. This block cools the gas after combustion, allowing the solid ash to be removed. The Heater block requires two thermodynamic specifications.

8 In the **Temperature** field, enter 400 F.

9 In the **Pressure** field, enter 14.7 psi.

10 Click  to continue.

The **CYCLONE | Input | Specifications** sheet appears.

To Learn About the Cyclone Model Using Help

1 From the main toolbar, click .

2 Click anywhere in the **CYCLONE | Input | Specifications** sheet. If a small popup help window appears, click the link for [Sheet Help](#).

The help for the Cyclone Input Specifications sheet appears.

3 In the **See Also** list at the end of the topic, click the [Specifying Cyclone](#) hypertext link.



4 Use the links, scrollbars, and arrow keys to move through the topics.

5 Aft **CLASES PARTICULARES, TUTORÍAS TÉCNICAS ONLINE
LLAMA O ENVÍA WHATSAPP: 689 45 44 70**

6 In **---**

7 In **ONLINE PRIVATE LESSONS FOR SCIENCE STUDENTS
CALL OR WHATSAPP:689 45 44 70**

No

- 8 Click  to continue.
The **ESP | Input | Specifications** sheet appears.
- 9 In the **Mode** field, click  and select *Design*.
- 10 In the **Separation efficiency** field, enter 0.995.

- 11 Click the **Dielectric Constant** tab.

12 Sp
sub
pur

CLASES PARTICULARES, TUTORÍAS TÉCNICAS ONLINE
LLAMA O ENVÍA WHATSAPP: 689 45 44 70

ONLINE PRIVATE LESSONS FOR SCIENCE STUDENTS
CALL OR WHATSAPP:689 45 44 70

Specifications
 Dielectric Constant
 Operation Options

Dielectric constant for each substream

Substream ID	Dielectric constant
CIPSD	5
NCPSD	5

13 Click  to continue.

CLASES PARTICULARES, TUTORÍAS TÉCNICAS ONLINE
 LLAMA O ENVÍA WHATSAPP: 689 45 44 70

ONLINE PRIVATE LESSONS FOR SCIENCE STUDENTS
 CALL OR WHATSAPP:689 45 44 70

Running the Simulation

The **Required Input Complete** dialog box appears.

- 1 Click **OK** to run the simulation.

The **Control Panel** allows you to monitor and interact with the Aspen Plus simulations calculations.

As Aspen Plus performs the simulation, status messages display in the **Control Panel**.

Aspen Plus reports four warnings while processing input specifications. Ignore these warnings, which are the same warnings that were generated in Simulation 2.

No further warnings are generated.

When the calculations finish, the message *Results Available* appears in the status area at the bottom right of the main window.

- 2 Use the vertical scrollbar to see the messages.
- 3 Examine the results of your run.

Examining Results



To View the Stream Results

- 1 From the Control Panel, click .

The **Results Summary | Run Status | Summary** sheet appears, indicating that the simulation completed normally.

- 2 Click  to access the next results sheet.

The **Results Summary | Streams | Material** sheet appears.

- 3 Review the results on this sheet. Use the horizontal and vertical scrollbars to review results that are off the screen.
- 4 In the **Display** field, click  and select *Streams*.
- 5 At the top of each column, click  and select *COOLPROD*, *CYC-SOL*, *FIL*

CLASES PARTICULARES, TUTORÍAS TÉCNICAS ONLINE
LLAMA O ENVÍA WHATSAPP: 689 45 44 70

- - -

ONLINE PRIVATE LESSONS FOR SCIENCE STUDENTS
CALL OR WHATSAPP:689 45 44 70

	COOLPROD	CYC-SOL	FILT-SOL	ESP-SOL	ESP-GAS
Temperature F	400.0	400.0	400.0	400.0	400.0
Pressure psi	14.700	14.484	13.984	13.983	13.983
Mass VFrac	0.993	0.000	0.000	0.000	1.000
Mass SFrac	0.007	1.000	1.000	1.000	< 0.001
*** ALL PHASES ***					
Mass Flow lb/hr	98333.333	551.999	125.867	12.003	97643.464

Compare the mass flow rate of ash in the streams. The cyclone removes 80% of the ash in COOLPROD. The fabric filter removes 91% of the ash not captured by the cyclone. Finally, the electrostatic precipitator captures virtually all of the remaining ash.

Compare the particle size distribution of the NCPDS substreams. The particle size distribution is a calculated result of the models. The cyclone removes the larger particles. The fabric filter removes the medium-size particles. The electrostatic precipitator removes the smaller particles.

- 6 Close the **Data Browser** window.

To View the Block Results

There are many results forms for these blocks. You can now examine any results of interest to you. This example guides you through a review of some of the simulation results.

- 1 From the **Process Flowsheet** window, right-click the CYCLONE block and from the shortcut menu, select **Results**.

The **CYCLONE | Results | Summary** sheet appears. This sheet reports the calculated geometry for the cyclone.

Summary		Balance
Type of cyclone:	High Efficiency	
Number of cyclones:	19	
Diameter of cylinder:	1.9284774	ft
Efficiency:	0.79999843	
Length of vortex:	4.77799174	ft
Length of cylinder:	2.8927161	ft

CLASES PARTICULARES, TUTORÍAS TÉCNICAS ONLINE
LLAMA O ENVÍA WHATSAPP: 689 45 44 70

ONLINE PRIVATE LESSONS FOR SCIENCE STUDENTS
CALL OR WHATSAPP:689 45 44 70

- 2 Close the **Data Browser** window.
- 3 From the **Process Flowsheet** window, right-click the BAG-FILT block and from the shortcut menu, select **Results**.

The **BAG-FILT | Results | Summary** sheet appears. This sheet displays results from the fabric filter calculations, including gas velocity and overall collection efficiency.

Summary		Balance
Fabfil results:		
Number of cells:	10	
Number of cells being cleaned:	1	
Number of bags per cell:	78	
Gas velocity:	0.04921259	ft/sec
Overall collection efficiency:	0.91207399	
Floor space required:	736.673418	sqft
Filtering time:	55.6301703	hr
Maximum pressure drop before cleaning:	0.5	psi

- 4 Close the **Data Browser** window.
- 5 From the **Process Flowsheet** window, right-click the ESP block and from the shortcut menu, select Results.

The **ESP | Results | Summary** sheet appears. This sheet reports the geometry, the collection efficiency, and the power requirements of the electrostatic precipitator.

Summary		Balance
ESP results:		
Gas velocity:	1.64041995	ft/sec
Number of plates:	26	
Plate height:	19.6960335	ft
Plate length:	20.6692913	ft
Overall collection efficiency:	0.99511706	
Corona voltage:	13467.8994	
Power requirement:	5.57369831	kw

CLASES PARTICULARES, TUTORÍAS TÉCNICAS ONLINE
 LLAMA O ENVÍA WHATSAPP: 689 45 44 70

ONLINE PRIVATE LESSONS FOR SCIENCE STUDENTS
 CALL OR WHATSAPP: 689 45 44 70

- 6 Clo

Exiting Aspen Plus

When finished working with this model, exit Aspen Plus as follows:

- 1 From the **Aspen Plus** menu bar, select **File | Exit**.

The **Aspen Plus** dialog box appears.

- 2 Click **Yes** to save the simulation.

Aspen Plus saves the simulation as the Aspen Plus Document file, Solid3.apw, in your default working directory (displayed in the **Save in** field).

CLASES PARTICULARES, TUTORÍAS TÉCNICAS ONLINE
LLAMA O ENVÍA WHATSAPP: 689 45 44 70

- - -

ONLINE PRIVATE LESSONS FOR SCIENCE STUDENTS
CALL OR WHATSAPP:689 45 44 70

4 Modeling Polymer Recovery

In this simulation you will model a simplified polymer washing and drying process.

You will use:

- Component attribute GENANAL to characterize a nonconventional (NC) component.
- The hydrocyclone model (HyCyc).
- The counter-current decanter model (CCD).
- The cyclone model (Cyclone).

Allow about 30 minutes to do this simulation.

**CLASES PARTICULARES, TUTORÍAS TÉCNICAS ONLINE
LLAMA O ENVÍA WHATSAPP: 689 45 44 70**

**ONLINE PRIVATE LESSONS FOR SCIENCE STUDENTS
CALL OR WHATSAPP:689 45 44 70**

Polymer Recovery Flowsheet

The process flow diagram and operating conditions for this simulation are shown in the following figure.

The feed stream FEED, a dilute slurry of polymer in acetone, is concentrated in a hydrocyclone. The concentrated slurry of polymer in acetone is then washed with water in a countercurrent decanter. The resulting slurry of polymer in water is dried with nitrogen. The gases from drying are separated from the solid polymer in a cyclone.

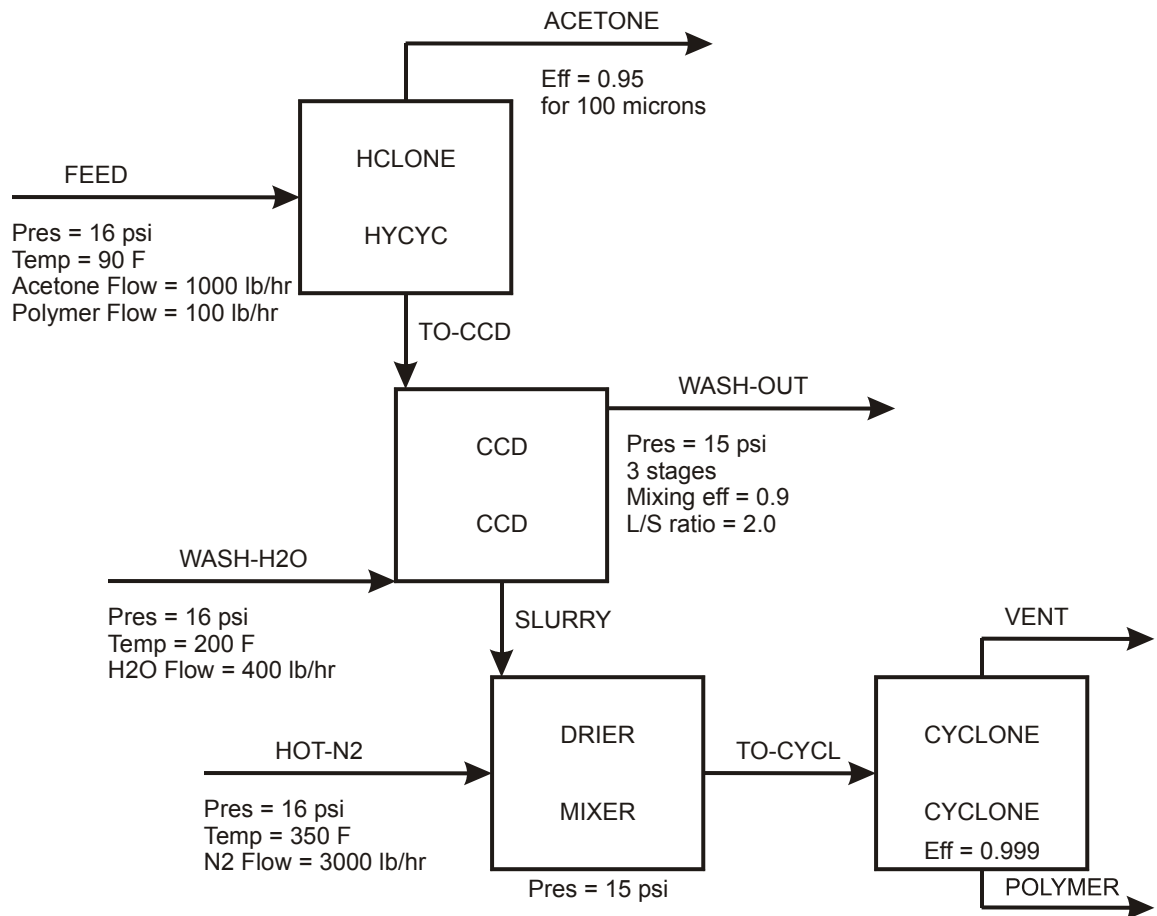

Starting Aspen Plus

- 1 Fro **CLASES PARTICULARES, TUTORÍAS TÉCNICAS ONLINE**
- 2 Sel **LLAMA O ENVÍA WHATSAPP: 689 45 44 70**
- Asp
- The
- Asp
- 3 Sel **ONLINE PRIVATE LESSONS FOR SCIENCE STUDENTS**
- CALL OR WHATSAPP:689 45 44 70**

- 4 Click **OK** to apply this option.

The **New** dialog box appears.

Use the **New** dialog box to specify the application type and the run type for the new run. Aspen Plus uses the application type you choose to automatically set various defaults appropriate to your application.

To Specify the Application Type and Run Type for the New Run

- 5 Select the *Solids with English Units* template.

The default **Run Type**, *Flowsheet*, is appropriate for this simulation.

- 6 Click **OK** to apply these options.

It takes a few seconds for Aspen Plus to apply these options.



Note: If the **Connect to Engine** dialog box appears, see Chapter 5.

The **Aspen Plus** main window is now active.

Drawing the Graphical Simulation Flowsheet

In this simulation, begin building the process flowsheet. Since you will enter your own block and stream IDs, turn off the automatic naming of blocks and streams, which provide these IDs automatically.

- 1 From the **Tools** menu, select **Options**.

The **Options** dialog box appears.

- 2 Select the **Flowsheet** tab.

- 3 Clear the **Automatically Assign Block Name with Prefix** and **Automatically Assign Stream Name with Prefix** checkboxes.

CLASES PARTICULARES, TUTORÍAS TÉCNICAS ONLINE
LLAMA O ENVÍA WHATSAPP: 689 45 44 70

- - -

ONLINE PRIVATE LESSONS FOR SCIENCE STUDENTS
CALL OR WHATSAPP:689 45 44 70

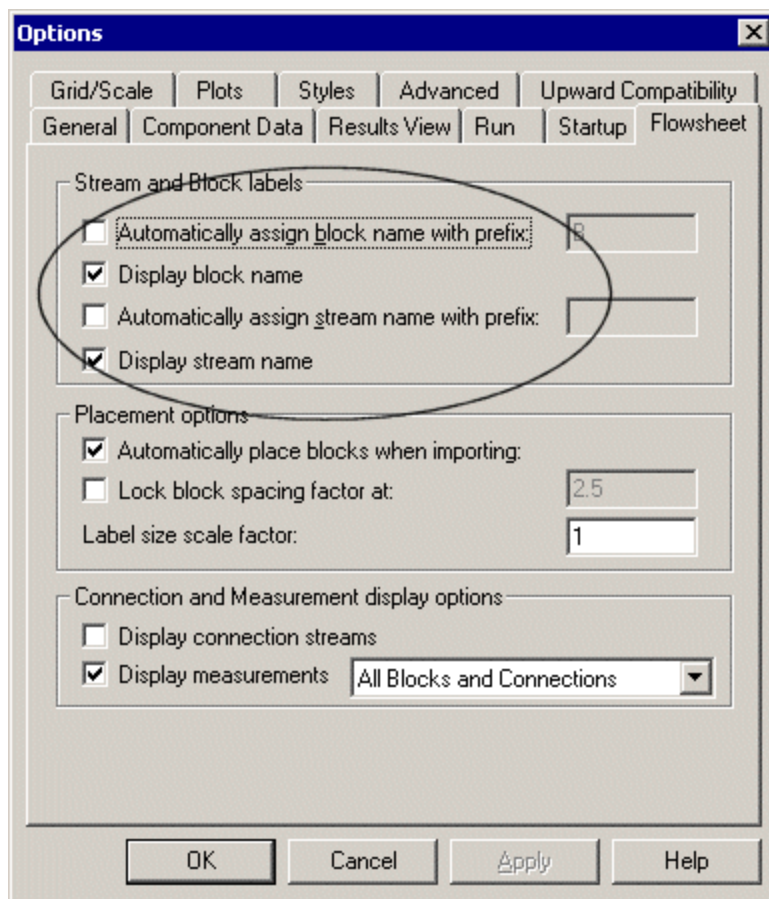

- 4 Click **OK** to close the **Options** dialog box and apply the changes.

CLASES PARTICULARES, TUTORÍAS TÉCNICAS ONLINE
LLAMA O ENVÍA WHATSAPP: 689 45 44 70

ONLINE PRIVATE LESSONS FOR SCIENCE STUDENTS
CALL OR WHATSAPP:689 45 44 70

To Change the Stream Class for the Simulation

- 1 From the **Flowsheet** menu, select **Flowsheet Sections**.
The **Flowsheet | Section** object Manager appears.
- 2 In the **Stream class** field, click  and select *MIXNCPSD*.

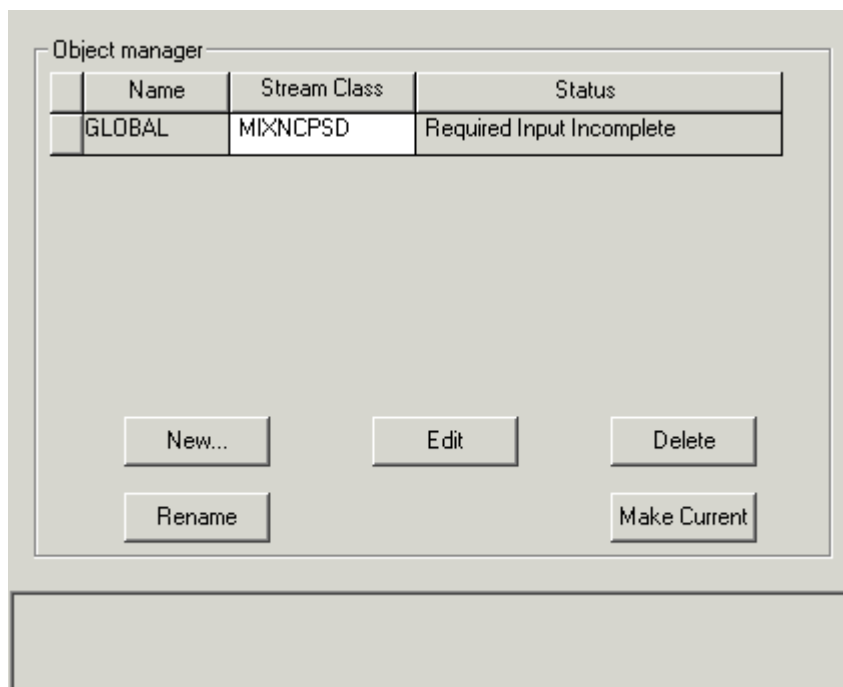



- 3 Click  to close the **Flowsheet Sections – Data Browser**.
- 4 Place the flowsheet blocks and streams to create the graphical simulation flowsheet shown below. (See *Getting Started Building and Running a Process Model*, Chapter 2, if you need to review how to create a graphical simulation flowsheet.)

CLASES PARTICULARES, TUTORÍAS TÉCNICAS ONLINE
LLAMA O ENVÍA WHATSAPP: 689 45 44 70

- - -

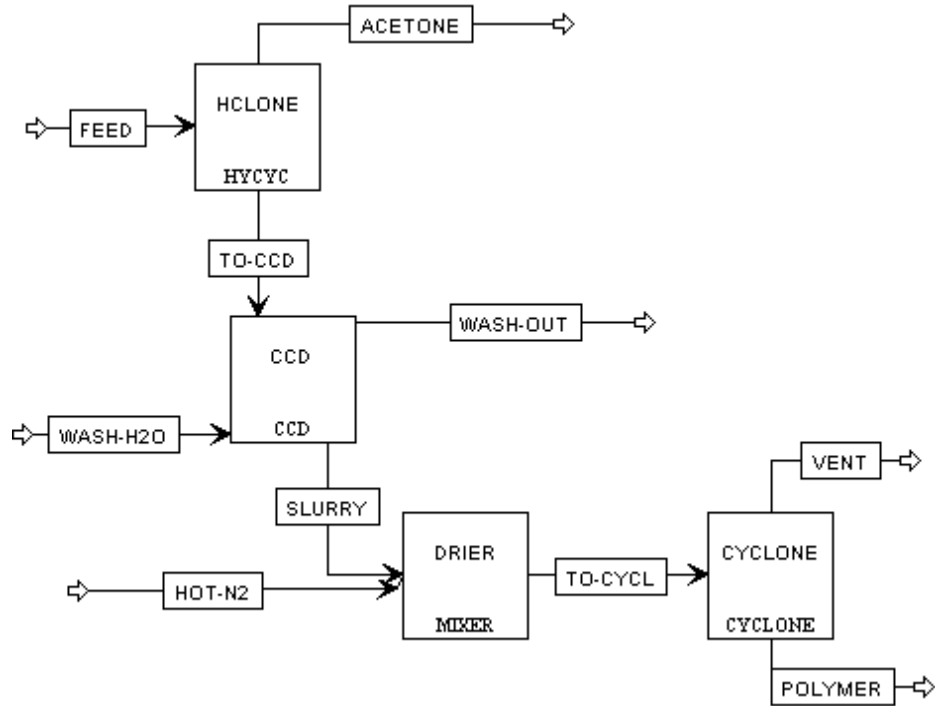
ONLINE PRIVATE LESSONS FOR SCIENCE STUDENTS
CALL OR WHATSAPP:689 45 44 70



- 5 When the flowsheet is complete as shown, click . The **Flowsheet Complete** dialog box appears.

CLASES PARTICULARES, TUTORÍAS TÉCNICAS ONLINE
 LLAMA O ENVÍA WHATSAPP: 689 45 44 70

ONLINE PRIVATE LESSONS FOR SCIENCE STUDENTS
 CALL OR WHATSAPP:689 45 44 70

Specifying Title, Stream Properties, and Global Options

- 1 Click **OK** to continue.

The **Data Browser** window appears. The **Setup | Specifications | Global** sheet displays defaults Aspen Plus uses for other forms. Use this sheet to give your simulation a title, and to review the stream properties and global options that were set when you selected the Solids with English Units application type.

The Run type field displays *Flowsheet*, which is appropriate for this simulation.

It is always good practice to describe your simulation by entering a title for the simulation.

- 2 In the **Title** field, enter *Getting Started with Solids - Simulation 4*.

The Solids with English Units application type sets the following global defaults for solids applications:

- *ENG* units (English Engineering Units).
- *Mass Flow* basis for all flow inputs.

There are no other changes required on the **Setup | Specifications | Global** sheet.

The screenshot shows the 'Global' tab of the Aspen Plus configuration window. The 'Title' field contains the text 'Getting Started with Solids - Simulation 4'. Below this, there are two main sections: 'Units of measurement' and 'Global settings'. In the 'Units of measurement' section, both 'Input data' and 'Output results' are set to 'ENG'. In the 'Global settings' section, 'Run type' is 'Flowsheet', 'Input mode' is 'Steady-State', 'Stream class' is 'MIXNCPSD', 'Flow basis' is 'Mass', 'Ambient pressure' is '14.69595 psi', 'Ambient temp.' is '50 F', and 'Valid phases' is empty. At the bottom of the 'Global settings' section, there is an unchecked checkbox labeled 'Use free water calculations'.

CLASES PARTICULARES, TUTORÍAS TÉCNICAS ONLINE
LLAMA O ENVÍA WHATSAPP: 689 45 44 70

ONLINE PRIVATE LESSONS FOR SCIENCE STUDENTS
CALL OR WHATSAPP:689 45 44 70

Since you chose the Solids with English Units application type when you started this simulation, Aspen Plus has set the following defaults for calculating and reporting stream properties:

- The component mass flow rates will be included in the stream report.
- The stream results will be displayed using the SOLIDS Stream Format.
- Property set ALL-SUBS (properties for the entire stream, all substreams combined) will be reported for each stream.

To Review the Report Options Specified in the Selected Template

- 1 From the **Data Browser** window, select the **Setup | Report Options** form.
- 2 Click the **Stream** tab to view the **Report Options | Stream** sheet.

The screenshot shows the 'Report Options | Stream' dialog box in Aspen Plus. The 'Stream' tab is active. The 'Generate a standard stream report' and 'Include stream descriptions' checkboxes are checked. Under 'Items to be included in stream report', the 'Flow basis' section has 'Mass' checked, and the 'Fraction basis' section has 'Mass' checked. The 'Stream format' dropdown is set to 'SOLIDS'. The 'Standard (80 column)' radio button is selected, and the 'Sort streams alphanumerically' checkbox is checked. At the bottom, there are buttons for 'Include Streams', 'Exclude Streams', 'Property Sets', 'Component Attributes', 'Stream Names', 'Batch Operation', and 'Supplementary Stream'.

- 3 Click **Property Sets** to view the selected property sets.
- 4 Click **Close** to return to the **Report Options | Stream** sheet.
- 5 Click  to continue.

The **Components | Specifications | Selection** sheet appears.

Sp CLASES PARTICULARES, TUTORÍAS TÉCNICAS ONLINE
LLAMA O ENVÍA WHATSAPP: 689 45 44 70

Use the
compo

The co
polyme



ONLINE PRIVATE LESSONS FOR SCIENCE STUDENTS
CALL OR WHATSAPP:689 45 44 70

- 1 On the first four **Component ID** fields, enter H2O, ACETONE, N2, and POLYMER.

Aspen Plus is able to find WATER, ACETONE and NITROGEN in the databanks. POLYMER is not found, so the **Component name** field for polymer is empty.

By default, Aspen Plus assumes all components have a **Type** of *Conventional*, indicating that they participate in phase equilibrium calculations. Change the **Type** for POLYMER to indicate that it is a solid. Because POLYMER does not have a precise molecular weight, assign POLYMER the **Type** *Nonconventional*.

Component ID	Type	Component name	Formula
H2O	Conventional	WATER	H2O
ACETONE	Conventional	ACETONE	C3H6O-1
N2	Conventional	NITROGEN	N2
POLYMER	Nonconventional		
*			

- 2 In the **Type** field for POLYMER, click  and select *Nonconventional*.
- 3 Click  to continue.

The **Properties | Specifications | Global** sheet appears.

CLASES PARTICULARES, TUTORÍAS TÉCNICAS ONLINE
LLAMA O ENVÍA WHATSAPP: 689 45 44 70

ONLINE PRIVATE LESSONS FOR SCIENCE STUDENTS
CALL OR WHATSAPP:689 45 44 70

Defining Properties

Use the **Properties | Specifications | Global** sheet to select the thermodynamic methods used to calculate properties such as K-values, enthalpy, and density. Property methods in Aspen Plus are arranged according to process types.

Select a Property Method

All property methods use the same physical property models for solid components. Therefore, the selection of the appropriate property method depends on the components that participate in phase equilibrium. Since acetone and water form a non-ideal solution, use an activity-coefficient-based option set. For this simulation, use the NRTL property method.

- 1 In the **Base method** field, click  and select *NRTL*.

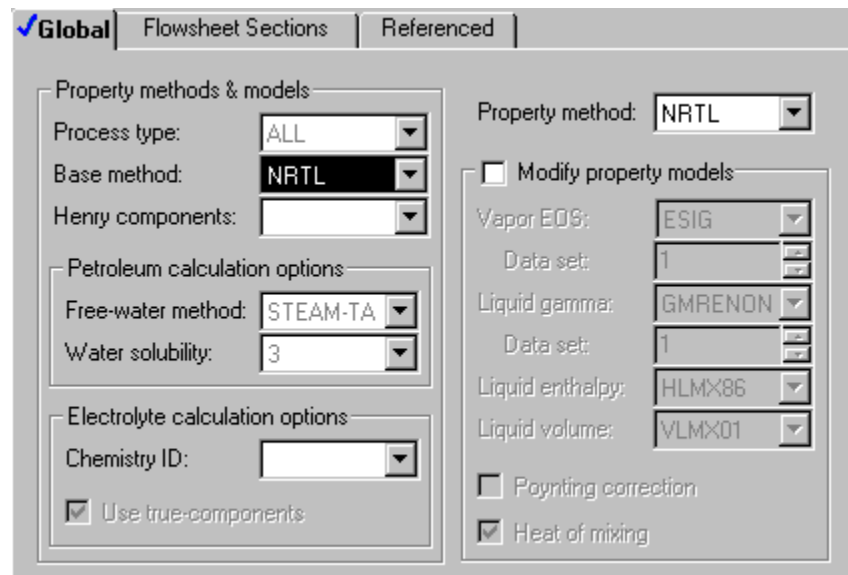

- 2 Click  to continue.

The **Properties | Parameters | Binary Interaction | NRTL-1 | Input** sheet appears.

On this sheet, Aspen Plus displays binary interaction parameters for the NRTL activity coefficient model. Binary parameters are retrieved for all binary combinations present in the database. If you had data for binary pairs, you could enter the data on this sheet.

Aspen Plus
available
the
con

CLASES PARTICULARES, TUTORÍAS TÉCNICAS ONLINE
LLAMA O ENVÍA WHATSAPP: 689 45 44 70

ONLINE PRIVATE LESSONS FOR SCIENCE STUDENTS
CALL OR WHATSAPP:689 45 44 70

In this example, parameters are retrieved for the acetone-water pair from the Aspen Plus VLE-IG databank. Aspen Plus displays the value of the parameters, and temperature range in which they were regressed. Use the vertical scrollbar at the bottom right to see all the parameter values.



- 3 Click  to continue.

Specify Nonconventional Component Property Methods

The **Properties | Advanced | NC Props | Property Methods** sheet appears.

Specify the methods for Aspen Plus to calculate the enthalpy and density of the nonconventional component POLYMER.

Use the general enthalpy model (ENTHGEN) and the general density model (DNSTYGEN) in this simulation.

- 4 In the **Model name** field for **Enthalpy**, click  and select *ENTHGEN*.
As soon as you select ENTHGEN, Aspen Plus assigns the attribute *GENANAL* to the component POLYMER.
- 5 In the **Model name** field for **Density**, click  and select *DNSTYGEN*.

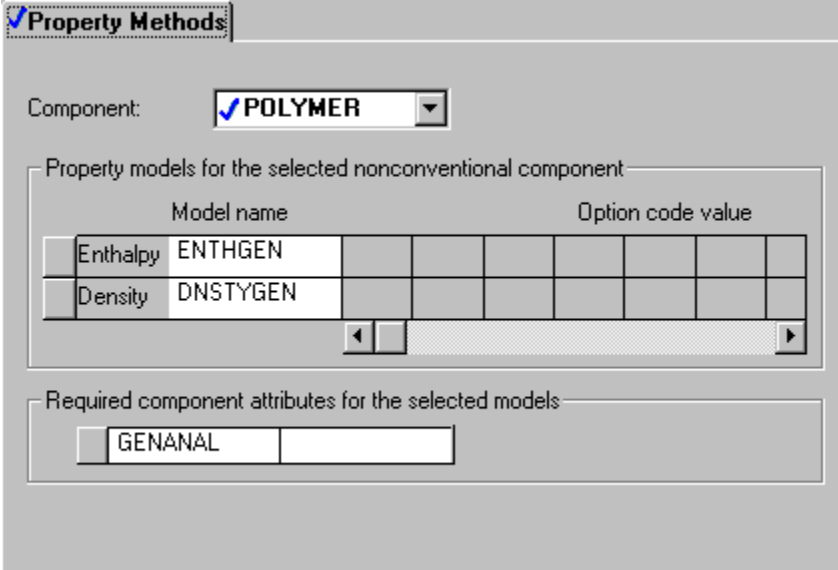

Property models for the selected nonconventional component	
Model name	Option code value
Enthalpy	ENTHGEN
Density	DNSTYGEN

Required component attributes for the selected models	
GENANAL	

You use GENANAL to characterize a nonconventional solid in terms of the

we
be
For
cor
rep
ine
cor
cor

**CLASES PARTICULARES, TUTORÍAS TÉCNICAS ONLINE
LLAMA O ENVÍA WHATSAPP: 689 45 44 70**

**ONLINE PRIVATE LESSONS FOR SCIENCE STUDENTS
CALL OR WHATSAPP:689 45 44 70**

In this simulation, use only the first constituent to characterize the component POLYMER. Thus, POLYMER will be composed of 100% constituent 1.

Specify Parameters Used to Calculate POLYMER Properties

Now provide Aspen Plus with the required parameters to calculate enthalpy and density for the nonconventional component POLYMER.

- 6** In the **Data Browser**, select the **Properties | Parameters | Pure Component** folder.

The **Properties | Parameters | Pure Component** object manager appears.

- 7** Click **New**.

The **New Pure Component Parameters** dialog box appears.

The enthalpy and density parameters for the POLYMER are of a Nonconventional type.

- 8** Select the *Nonconventional* option.

- 9** Click **OK** to accept the default ID, NC-1.

The **Properties | Parameters | Pure Component | NC-1 | Input** sheet appears.

The ENTHGEN model calculates enthalpy from the parameters DHFGEN and HCGEN. In this simulation DHFGEN (heat of formation) is not required since POLYMER does not participate in any chemical reactions. You must provide HCGEN (heat capacity). For this simulation, POLYMER is assumed to have a constant heat capacity of 0.45 Btu/lb-R.

- 10** In the **Parameter** field, click and select *HCGEN*.

- 11** In the first field in the **Nonconventional component parameter** frame, click and select *POLYMER*.

- 12** In the first parameter value field directly below, enter 0.45.

CLASES PARTICULARES, TUTORÍAS TÉCNICAS ONLINE
LLAMA O ENVÍA WHATSAPP: 689 45 44 70

- - -

ONLINE PRIVATE LESSONS FOR SCIENCE STUDENTS
CALL OR WHATSAPP:689 45 44 70

Input

Parameter: HCGEN Btu/lb-R Temperature units: F

Nonconventional component parameter

<input type="checkbox"/>	POLYMER	
<input type="checkbox"/>	0.45	
<input type="checkbox"/>		
<input type="checkbox"/>		
<input type="checkbox"/>		
<input type="checkbox"/>		
<input type="checkbox"/>		

The first four elements of HCGEN are used to calculate the heat capacity of the first constituent of GENANAL, using the following equation:

$$C_p = \text{HCGEN}(1) + \text{HCGEN}(2) \times T + \text{HCGEN}(3) \times T^2 + \text{HCGEN}(4) \times T^3$$

HCGEN(2), HCGEN(3) and HCGEN(4) default to zero. Since only the first constituent of GENANAL will be used to characterize POLYMER, POLYMER will have a constant heat capacity of 0.45 Btu/lb-R.

If POLYMER were characterized with other constituents, use elements 5 through 8 of HCGEN to calculate the heat capacity of the second constituent, and so on.

Enter the parameters required for the DNSTYGEN model on this sheet. DNSTYGEN calculates density for a nonconventional solid from the DENGGEN parameter. For this simulation, POLYMER is assumed to have a constant density of 80 lb/cuft.

- 13 In the **Parameter** field, click and select *DENGGEN*.
- 14 In the first field in the **Nonconventional component parameter** frame, click and select *POLYMER*.
- 15 In the first parameter value field, enter 80.

CLASES PARTICULARES, TUTORÍAS TÉCNICAS ONLINE
LLAMA O ENVÍA WHATSAPP: 689 45 44 70

- - -

ONLINE PRIVATE LESSONS FOR SCIENCE STUDENTS
CALL OR WHATSAPP:689 45 44 70

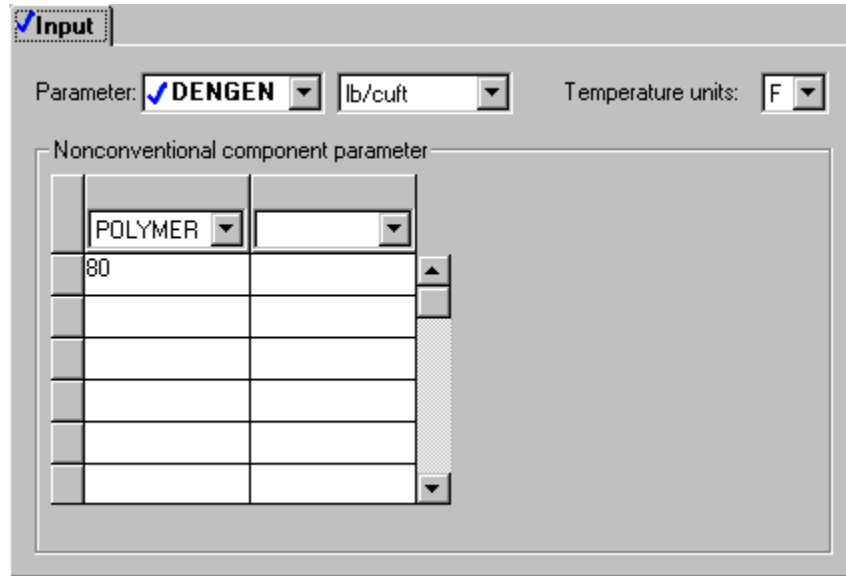

16 Click  to continue.

The **Required Properties Input Complete** dialog box appears.

Correct representation of physical properties is an essential component of process modeling. For many simulations, the only physical property specification that you must provide is the selection of an option set. The **Required Properties Input Complete** dialog box shows that the Aspen Plus physical property system has many optional capabilities that you can use to increase the accuracy of physical property calculations.

17 Click **OK** to move to the next required input.

Defining Stream Conditions

The **Streams FEED Input Specifications** sheet appears.

For the MIXED substream, Aspen Plus requires two thermodynamic specifications, and enough information to calculate the flow rate of each component.

1 Enter the following specifications for the MIXED substream:

Temperature	90.0 F
Pressure	16.0 psi
Composition	Mass-Flow

AC CLASES PARTICULARES, TUTORÍAS TÉCNICAS ONLINE
 LLAMA O ENVÍA WHATSAPP: 689 45 44 70

- - -

ONLINE PRIVATE LESSONS FOR SCIENCE STUDENTS
 CALL OR WHATSAPP:689 45 44 70

Specifications Flash Options PSD Component Attr. EO Options

Substream name: MIXED Ref Temperature

State variables

Temperature

Pressure

Total flow:

Solvent:

Composition

Mass-Flow

Component	Value
H2O	
ACETONE	1000
N2	

Total:

You can access other substreams for stream FEED by changing the substream name.

- In the **Substream name** field, click and select *NCPSD*.
- Enter the following specifications for the mixed substream:

Temperature 90.0 F
Pressure 16.0 psi
Composition Mass-Flow
POLYMER value 100 lb/hr

The **Streams FEED Input Specifications** sheet is now complete.

Specifications Flash Options PSD Component Attr. EO Options

Substream name: NCPSD Ref Temperature

State variables

Temperature

Pressure

Total flow:

Solvent:

Composition

Mass-Flow

Component	Value
POLYMER	100

CLASES PARTICULARES, TUTORÍAS TÉCNICAS ONLINE
 LLAMA O ENVÍA WHATSAPP: 689 45 44 70

- Click **ONLINE PRIVATE LESSONS FOR SCIENCE STUDENTS
 CALL OR WHATSAPP:689 45 44 70**

The **Streams | FEED | Input | PSD** sheet appears. Use this sheet to define the particle size distribution for the POLYMER that you placed in the NCPSD substream.

By default, Aspen Plus uses a particle size distribution of 10 size ranges covering 20 microns each. The default size ranges are appropriate for this simulation. On this sheet, enter the weight fraction of coal in each size range.

- 5 In the **Weight fraction** fields, enter the following values:

Interval	Weight Fraction
6	0.2
7	0.3
8	0.3
9	0.2

- 6 Click  to continue.

The **Stream | FEED | Input | Component Attr.** sheet appears. On this sheet, define the component POLYMER in terms of the constituents in its GENANAL. Aspen Plus does not require you to use all 20 constituents. Since you are using only the first constituent to characterize POLYMER, the first element of GENANAL is 100%.

- 7 In the **ELEM1** field, enter a value of 100.

CLASES PARTICULARES, TUTORÍAS TÉCNICAS ONLINE
 LLAMA O ENVÍA WHATSAPP: 689 45 44 70

ONLINE PRIVATE LESSONS FOR SCIENCE STUDENTS
 CALL OR WHATSAPP:689 45 44 70

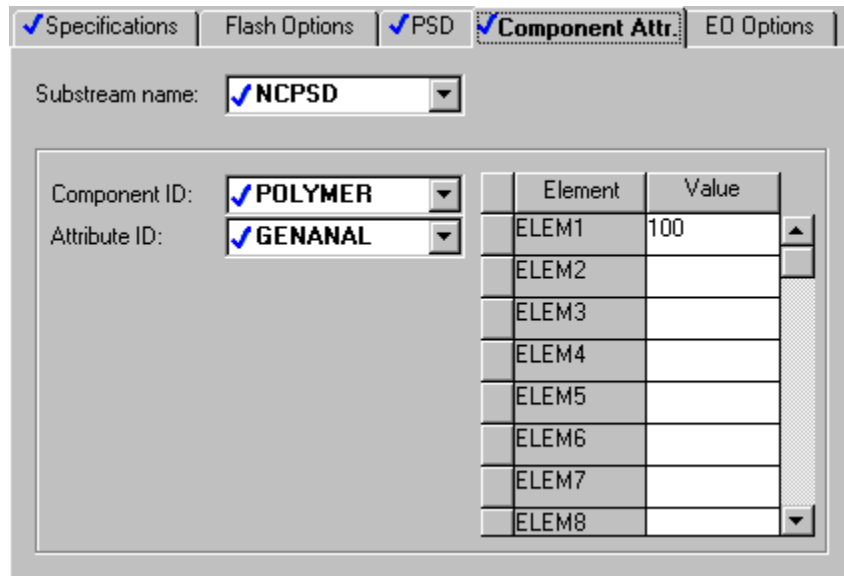

8 Click  to continue.

The **Streams | HOT-N2 | Input | Specifications** sheet appears.

Stream HOT-N2 is the feed stream used to dry the polymer.

9 Enter the following specifications for the MIXED substream:

Temperature 350.0 F
Pressure 16.0 psi
Composition Mass-Flow
N2 value 3000 lb/hr

10 Click  to continue.

The **Streams | WASH-H2O | Input | Specifications** sheet appears.

Stream WASH-H2O is the feed stream used to wash the polymer in the CCD.

11 Enter the following specifications for the MIXED substream:

Temperature 200.0 F
Pressure 16.0 psi
Composition Mass-Flow
H2O value 400 lb/hr

12 Click  to continue.

CLASES PARTICULARES, TUTORÍAS TÉCNICAS ONLINE
 LLAMA O ENVÍA WHATSAPP: 689 45 44 70

ONLINE PRIVATE LESSONS FOR SCIENCE STUDENTS
 CALL OR WHATSAPP:689 45 44 70

Entering Block Specifications

The **Blocks | CCD | Input | Specifications** sheet appears.

Enter Specifications for the CCD Model

Make the following specifications for a countercurrent decanter:

- Number of stages.
- Operating pressure.
- Mixing efficiency.
- Liquid/solid ratio.

If you do not provide mixing efficiency or liquid/solid ratio for all stages, Aspen Plus determines the values for missing stages by linear interpolation. If you provide only a single value for mixing efficiency or liquid/solid ratio, Aspen Plus uses that value for all stages.

By default, Aspen Plus assumes each stage of a countercurrent decanter to be adiabatic. Alternatively, you could specify a temperature, a heat duty, or a heat transfer coefficient for each stage.

1 Enter the following operating conditions:

Number of stages	3
Pressure	15.0 psi

2 For the stage profiles, enter:

Stage	1
Mixing efficiency	0.9
Liquid-to-solid mass ratio	2

The screenshot shows the 'Specifications' dialog box with the following data:

Operating conditions	
Number of stages:	3
Pressure:	15 psi
Ambient temperature:	77 F

Stage profiles		
Stage	Mixing efficiency	Liquid-to-solid mass ratio
1	0.9	2

CLASES PARTICULARES, TUTORÍAS TÉCNICAS ONLINE
LLAMA O ENVÍA WHATSAPP: 689 45 44 70

ONLINE PRIVATE LESSONS FOR SCIENCE STUDENTS
CALL OR WHATSAPP:689 45 44 70



- 3 Click the **Streams** tab.

The **CCD | Input | Streams** sheet describes the connections of the streams to the stages of the CCD. It is already complete.

- 4 Click  to continue.

The **Cyclone | Input | Specifications** sheet appears.

To Learn More about the Cyclone Model Using Help

- 1 From the main toolbar, click .
- 2 Click anywhere on the **Cyclone | Input | Specifications** sheet. If a small popup help window appears, click the link for [Sheet Help](#).
The help for the Cyclone Input Specifications sheet appears.
- 3 In the list of **See Also** links, click the [Specifying Cyclone](#) hypertext link.
- 4 Use the links, scrollbars, and arrow keys to move through the topics.
- 5 After reviewing the help, click  to close the help window.

You can use the Cyclone model in simulation mode or design mode. In this simulation, use Cyclone in design mode. Aspen Plus will determine the dimensions and the number of cyclones required to achieve a specified efficiency for solids removal.

Enter Specifications for the Cyclone Model

- 6 In the **Mode** field, click  and select *Design*.
- 7 In the **Separation efficiency** field, enter a separation efficiency of 0.999.

CLASES PARTICULARES, TUTORÍAS TÉCNICAS ONLINE
LLAMA O ENVÍA WHATSAPP: 689 45 44 70

- - -

ONLINE PRIVATE LESSONS FOR SCIENCE STUDENTS
CALL OR WHATSAPP:689 45 44 70

Specifications	Dimensions	Ratios	Efficiency	Solids Loading
Calculation options				
Mode:	Design	Efficiency correlation:	Leith-Licht	
Type:	High efficiency	Vane constant:		
Design parameters				
Separation efficiency:	0.999			
Maximum pressure drop:	0.2175566	psi		
Maximum no. of cyclones:	100			
Design convergence options				
Maximum iterations:	30			
Error tolerance:	0.0001			

8 Click  to continue.

The **DRIER | Input | Flash Options** sheet appears. The sheet is marked complete, since there are no specifications required for a Mixer block. However, Aspen Plus does allow the pressure of the Mixer as an optional specification.

To Specify That the Mixer Block DRIER Operates at 15 psi

1 In the **Pressure** field, enter 15.0 psi.

2 Click  to continue.

The **HCLONE | Input | Specifications** sheet appears.

3 From the toolbar, click .

4 Click anywhere on the **Specifications** sheet.

5 Use the links, scrollbars, and arrow keys to move through the topics.

6 After reviewing the help, click  to close the help window.

CLASES PARTICULARES, TUTORÍAS TÉCNICAS ONLINE
LLAMA O ENVÍA WHATSAPP: 689 45 44 70

ONLINE PRIVATE LESSONS FOR SCIENCE STUDENTS
CALL OR WHATSAPP:689 45 44 70

Enter Specifications for the HyCyc Model

You can use HyCyc in simulation mode or design mode. In this example, use HyCyc in design mode. In design mode, make the following specifications:

- Particle size for design efficiency.
- Design separation efficiency.
- Maximum diameter of the hydrocyclone.
- Maximum pressure drop.

7 In the **Mode** field, click  and select *Design*.

8 Enter the following specifications:

Diameter of solid particles 100 mu (microns)

Separation efficiency 0.95

Maximum diameter 1.5 ft

Maximum pressure drop 5.0 psi

Be sure to specify the units of measure for the particle diameter.

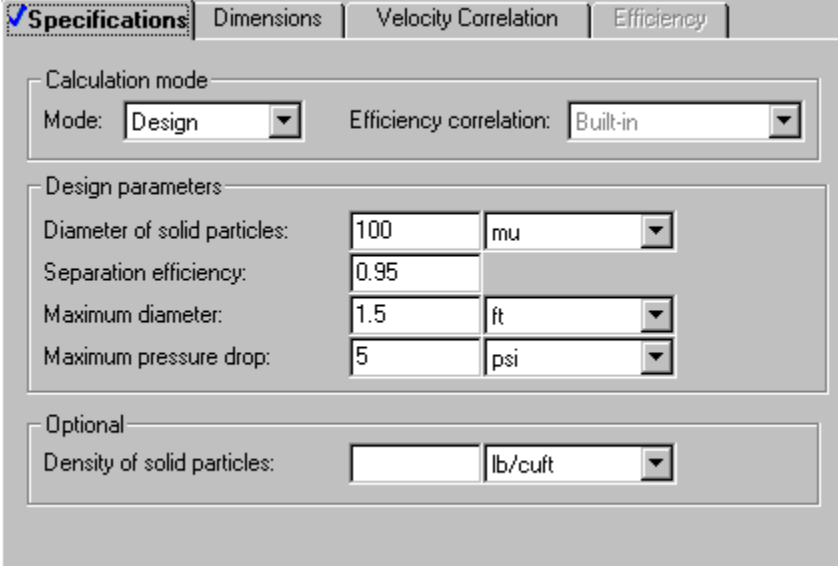

Field	Value	Unit
Mode	Design	
Efficiency correlation	Built-in	
Diameter of solid particles	100	mu
Separation efficiency	0.95	
Maximum diameter	1.5	ft
Maximum pressure drop	5	psi
Density of solid particles		lb/cuft

To help concentrate the solid slurry, change the default geometry of the hydrocyclone. Increasing the size of the overflow diameter increases the amount of liquid product in stream ACETONE. Specify that the ratio of the overflow diameter to the inlet diameter is 1.5.

9 Click

10 In

CLASES PARTICULARES, TUTORÍAS TÉCNICAS ONLINE
LLAMA O ENVÍA WHATSAPP: 689 45 44 70

ONLINE PRIVATE LESSONS FOR SCIENCE STUDENTS
CALL OR WHATSAPP:689 45 44 70

Specifications **Dimensions** Velocity Correlation Efficiency

Ratios of dimensions to hydrocyclone diameter

Length of cylinder: 5

Diameter of inlet: 0.1429

Diameter of overflow: 0.3

Diameter of underflow: 0.15

Dimensions of hydrocyclone

Cone angle: 20 deg

11 Click  to continue.

The **Required Input Complete** dialog box appears.

CLASES PARTICULARES, TUTORÍAS TÉCNICAS ONLINE
LLAMA O ENVÍA WHATSAPP: 689 45 44 70

ONLINE PRIVATE LESSONS FOR SCIENCE STUDENTS
CALL OR WHATSAPP:689 45 44 70

Running the Simulation

You have now entered the data and specifications for this simulation.

- 1 Click **OK** to run the simulation.

The **Control Panel** allows you to monitor and interact with the Aspen Plus simulations calculations.

As Aspen Plus performs the simulation, status messages display in the **Control Panel**.

GENANAL is defined as having 20 constituents. If you only use a portion of the constituents available in GENANAL, Aspen Plus generates a warning. Since you need only one element in GENANAL for this simulation, ignore this warning. The remainder of the simulation completes without warnings or errors.

When the calculations finish, the message *Results Available* appears in the status area at the bottom right of the main window.

- 2 Use the vertical scrollbar to see the messages.
- 3 Examine the results of your run.

Examining Results

To View the Stream Results

- 1 From the **Control Panel**, click .

The **Results Summary | Run Status | Summary** sheet appears, indicating that the simulation completed normally.

- 2 Click  to move to the next sheet with results.

The **Results Summary | Streams | Material** sheet appears.

- 3 Review the results on this sheet.



Note: Since this is a scrolling sheet, use the scrollbars to review results that are off the screen.

- 4 In the **Display** field, select *Streams*.

- 5 At the bottom of the sheet, click **CLASES PARTICULARES, TUTORÍAS TÉCNICAS ONLINE**
sub...
SL...

- 6 Evaluate the stream results. **---**
ONLINE PRIVATE LESSONS FOR SCIENCE STUDENTS
CALL OR WHATSAPP:689 45 44 70

	ACETONE	TO-CCD	WASH-H2O	WASH-OUT	SLURRY
Density lb/cuft	48.513	57.102	57.741	52.320	62.620
Mass Flow lb/hr					
H2O			400.000	217.048	182.952
ACETONE	839.173	160.827		144.576	16.251
N2					
POLYMER	0.398	99.602			99.602

Most of the acetone and very little of the polymer are in stream ACETONE. The hydrocyclone has substantially concentrated the dilute slurry of polymer in acetone to feed to the CCD.

- 7 Evaluate the performance of the countercurrent decanter by comparing streams TO-CCD, WASH-OUT, and SLURRY.

Most of the acetone in TO-CCD is removed by the wash water. Stream SLURRY contains polymer in a water rich environment. Note that stream WASH-OUT contains no polymer.

- 8 After the SLURRY column, click  and select the following streams *HOT-N2*, *TO-CYCL*, *VENT*, and *POLYMER*.

	HOT-N2	TO-CYCL	VENT	POLYMER
Density lb/cuft	0.052	0.068	0.066	80.000
Mass Flow lb/hr				
H2O		182.952	182.952	
ACETONE		16.251	16.251	
N2	3000.000	3000.000	3000.000	
POLYMER		99.602	0.100	99.502

The DRIER block operates by mixing streams SLURRY and HOT-N2. There is enough hot nitrogen to adiabatically evaporate all of the liquid in stream SLURRY ($V_{frac} + S_{frac} = 1$ in stream TO-CYCL).

The CYCLONE block separates the solid polymer from the gas. Because the Cyclone model neglects the interstitial flow of gas in the separated solids, stream POLYMER contains a small amount of acetone.

- 9 Clo

**CLASES PARTICULARES, TUTORÍAS TÉCNICAS ONLINE
LLAMA O ENVÍA WHATSAPP: 689 45 44 70**

**ONLINE PRIVATE LESSONS FOR SCIENCE STUDENTS
CALL OR WHATSAPP:689 45 44 70**

To View the Block Results

- 1 In the **Process Flowsheet** window, right-click the CCD block. From the shortcut menu, select **Results**.

The **CCD | Results | Summary** sheet appears. This sheet displays summary flow and temperature information for the first and last stages.

Summary		
Balance		
Profiles		
CCD results		
	Mass flow	Temperature
	lb/hr	F
Top stage feed:	260.428866	90
Bottom stage feed:	400	200
Total side feed:	0	
Top stage product:	361.623696	169.974076
Bottom stage product:	298.80517	194.419557
Side draw (under):	0	
Side draw (over):	0	
Total duty:	0	Btu/hr

- 2 Click  to move to the next sheet with results.

The **CCD | Results | Balance** sheet appears. This sheet displays the overall mass and energy balance for the block.

- 3 Click  to move to the next sheet with results.

The **CCD | Results | Profiles** sheet appears. This sheet displays the temperature, duty, underflow, and overflow for each stage of the CCD.

Summary					
Balance					
Profiles					
Stage	Temperature	Duty	Underflow	Overflow	Feed
	F	Btu/hr	lb/hr	lb/hr	lb/hr
1	169.974076	0	99.6017235	560.827143	260.428866
2	185.194297	0	99.6017235	599.203447	0

- 4 Click  to move to the next sheet with results.

- 5 In the **Process Flowsheet** window, right-click the CCD block. From the shortcut menu, select **Results**.

CLASES PARTICULARES, TUTORÍAS TÉCNICAS ONLINE
LLAMA O ENVÍA WHATSAPP: 689 45 44 70

ONLINE PRIVATE LESSONS FOR SCIENCE STUDENTS
CALL OR WHATSAPP:689 45 44 70

The **CYCLONE | Results | Summary** sheet appears. This sheet displays the calculated geometry for the cyclone.

Summary		Balance
Type of cyclone:	High Efficiency	
Number of cyclones:	1	
Diameter of cylinder:	2.30488322	ft
Efficiency:	0.9990009	
Length of vortex:	5.71057403	ft
Length of cylinder:	3.45732482	ft
Length of cone:	5.76220804	ft
Diameter of gas outlet:	1.15244161	ft
Length of gas outlet:	1.15244161	ft
Width of gas inlet:	0.46097664	ft

- 6 Click  to move to the next sheet with results.

The **CYCLONE | Results | Balance** sheet appears. This sheet displays the overall mass and energy balance for the block.

- 7 Close the **Data Browser** window.

- 8 In the **Process Flowsheet** window, right-click the DRIER block. From the shortcut menu, select **Results**.

The **DRIER | Results | Summary** sheet appears. This sheet displays the outlet thermodynamic conditions for the block.

Summary		Balance
Mixer results		
Outlet temperature:	117.92368	F
Outlet pressure:	15	psi
Vapor fraction:	1	
1st liquid/Total liquid:	1	

- 9 Click  to move to the next sheet with results.

The **DRIER | Results | Balance** sheet appears. This sheet displays the overall mass and energy balance for the block.

- 10 Close the **Data Browser** window.

- 11 In the **Process Flowsheet** window, right-click the DRIER block. From the shortcut menu, select **Results**.

The **DRIER | Results | Summary** sheet appears. This sheet displays the outlet thermodynamic conditions for the block.

The **DRIER | Results | Balance** sheet appears. This sheet displays the overall mass and energy balance for the block.

CLASES PARTICULARES, TUTORÍAS TÉCNICAS ONLINE
 LLAMA O ENVÍA WHATSAPP: 689 45 44 70

ONLINE PRIVATE LESSONS FOR SCIENCE STUDENTS
 CALL OR WHATSAPP:689 45 44 70

Summary		Balance
HyCyc results		
Number of hydrocyclones:	1	
Pressure drop:	0.04698575	psi
Length of cylinder:	2.09890401	ft
Diameter of cylinder:	0.4197808	ft
Diameter of inlet:	0.05998667	ft
Diameter of overflow:	0.12593424	ft
Diameter of underflow:	0.06296712	ft
Inlet liquid velocity:	2.02635729	ft/sec
Liquid volumetric flow per cyclone:	20.616694	cuft/hr

Exiting Aspen Plus

When you are finished working with this model, you can exit Aspen Plus as follows:

- 1 From the **Aspen Plus** menu bar, select **File | Exit**.
The **Aspen Plus** dialog box appears.
- 2 Click **Yes** to save the simulation.
- 3 In the **Save As** dialog box, enter the Run ID *Solid4* in the **File name** box.

Aspen Plus saves the simulation as the Aspen Plus Document file, *Solid4.apw*, in your default working directory (displayed in the **Save in** box).

This simulation is delivered as backup file *solid4* in the online Aspen Plus Examples Library. You can use this backup file to check your results.

CLASES PARTICULARES, TUTORÍAS TÉCNICAS ONLINE
LLAMA O ENVÍA WHATSAPP: 689 45 44 70

- - -

ONLINE PRIVATE LESSONS FOR SCIENCE STUDENTS
CALL OR WHATSAPP:689 45 44 70

5 Connecting to the Aspen Plus Simulation Engine

If either of the following conditions exist, you will be prompted to specify the host computer for the Aspen Plus simulation engine after you start the Aspen Plus User Interface:

- The simulation engine is not installed on your PC.
- The simulation engine is installed on your PC, but the Activator security device is not connected to your PC.

In these cases, the **Connect to Engine** dialog box appears.

- 1 In the **Server type** field, click and select the type of host computer for the simulation engine.

If you choose *Local PC* as the server for the simulation engine, you do not need to enter any more information into the dialog box.

If you choose *Windows 2000 or XP server* as the server for the simulation engine, enter additional information:

- 2 In the **Node name** field, enter the node name of the computer on which the Aspen Plus simulation engine will execute.
- 3 In the other fields, enter the following information:

User name Your user name for the specified host/server.

Password Your password for the above user name.

Working directory The associated working directory.

- 4 Click **OK** to continue.

- 5 When the network connection is established, the message *Connection Established* appears in the message box.



Note: If the *Connection Established* message does not appear, see your Aspen Plus system administrator for more information on network protocols and host computers for the Aspen Plus simulation engine.

General Information

This section provides Copyright details and lists any other documentation related to this release.

Copyright

Version Number: 2004.1

April 2005

Copyright © 1981 – 2005 Aspen Technology, Inc. All rights reserved.

Aspen ACOL™, Aspen Adsim®, Aspen Advisor™, Aspen Aero™, Aspen Alarm & Event™, Aspen APLE™, Aspen Apollo Desktop™, Aspen Apollo Online™, Aspen AssetBuilder™, Aspen ATOMS™, Aspen Automated Stock Replenishment™, Aspen Batch Plus®, Aspen Batch.21™, Aspen BatchCAD™, Aspen BatchSep™, Aspen Calc™, Aspen Capable-to-Promise®, Aspen CatRef®, Aspen Chromatography®, Aspen Cim-IO for ACS™, Aspen Cim-IO for Csi VXL™, Aspen Cim-IO for Dow MIF™, Aspen Cim-IO for G2™, Aspen Cim-IO for GSE D/3™, Aspen Cim-IO for Hewlett-Packard RTAP™, Aspen Cim-IO for Hitachi PLC (H04E)™, Aspen Cim-IO for Intellution Fix™, Aspen Cim-IO for Melsec™, Aspen Cim-IO for WonderWare InTouch™, Aspen Cim-IO for Yokogawa Centum CS™, Aspen Cim-IO for Yokogawa Centum XL™, Aspen Cim-IO for Yokogawa EW3™, Aspen Cim-IO Interfaces™, Aspen Cim-IO Monitor™, Aspen Cim-IO™, Aspen Collaborative Demand Management™, Aspen Collaborative Forecasting™, Aspen Compliance.21™, Aspen COMThermo TRC Database™, Aspen COMThermo®, Aspen Cost Factor Manual™, Aspen Crude Manager™, Aspen Crude Margin Evaluation™, Aspen Custom Modeler®, Aspen Data Source Architecture™, Aspen Decision Analyzer™, Aspen Demand Manager™, Aspen DISTIL™, Aspen Distribution Scheduler™, Aspen DMCplus® Composite, Aspen DMCplus® Desktop, Aspen DMCplus® Online, Aspen DPO™, Aspen Dynamics®, Aspen eBRS™, Aspen Enterprise Model™, Aspen ERP Connect™, Aspen FCC®, Aspen FIHR™, Aspen FLARENET™, Aspen Fleet Operations Management™, Aspen Framework™, Aspen FRAN™, Aspen Fuel Gas Optimizer Desktop™, Aspen Fuel Gas Optimizer Online™, Aspen General Construction Standards™, Aspen Hetran®, Aspen HX-Net®, Aspen Hydrocracker®, Aspen Hydrotreater™, Aspen HYSYS Amines™, Aspen HYSYS Crude™, Aspen HYSYS Dynamics™, Aspen HYSYS OLGAS 3-Phase™, Aspen HYSYS OLGAS™, Aspen HYSYS OLI Interface™, Aspen HYSYS Tacite™, Aspen HYSYS Upstream Dynamics™, Aspen HYSYS Upstream™, Aspen HYSYS®, Aspen Icarus Process Evaluator®, Aspen Icarus Project Manager®, Aspen InfoPlus.21®, Aspen Inventory Balancing™, Aspen IQ Desktop™, Aspen IQ Online™, Aspen IQmodel Powertools™, Aspen Kbase®, Aspen LIMS Interface™, Aspen Local Security™, Aspen LPIMS™, Aspen MBO™, Aspen MIMI®, Aspen MPIMS™, Aspen Multivariate Server™, Aspen MUSE™, Aspen NPIMS™, Aspen OnLine®, Aspen Operations Manager - Event Management™, Aspen Operations Manager - Integration Infrastructure™, Aspen Operations Manager - Performance Scorecarding™, Aspen Operations Manager - Role Based Visualization™, Aspen Order Credit Management™, Aspen Orion Planning™, Aspen Orion™, Aspen PEP Process Library™, Aspen PIMS Blend Model Library™, Aspen PIMS Distributed Processing™, Aspen PIMS Enterprise Edition™, Aspen PIMS Mixed Integer Programming™, Aspen PIMS Simulator Interface™, Aspen PIMS Solution Ranging™, Aspen PIMS Submodel Calculator™, Aspen PIMS XNLP Optimizer™, Aspen PIMS™, Aspen PIPESYS™, Aspen PIPE™, Aspen Planning Accuracy™, Aspen Plant Planner & Scheduler™, Aspen Plant Scheduler Lite™, Aspen Plant Scheduler™, Aspen Plus OLI Interface™, Aspen Plus®, Aspen Polymers Plus®, Aspen PPIMS™, Aspen Process Data™, Aspen Process Explorer™, Aspen Process Manual™, Aspen Process Order™, Aspen Process Plant Construction Standards™, Aspen Process Recipe®, Aspen Process Tools™, Aspen Product Margin & Blending Evaluation™, Aspen Production Control Web Server™, Aspen ProfES® 2P Tran, Aspen ProfES® 2P Wax, Aspen ProfES® 3P Tran, Aspen ProfES® Tranflo, Aspen Properties®, Aspen Pumper Log™, Aspen Q Server™, Aspen RateSep™, Aspen RefSYS CatCracker™, Aspen RefSYS Spiral™, Aspen RefSYS™, Aspen Report Writer™, Aspen Resource Scheduling Optimization™, Aspen RTO Watch Cim-IO Server™, Aspen RTO Watch Server™, Aspen Scheduling & Inventory Management™, Aspen SmartStep Desktop™, Aspen SmartStep Online™, Aspen SQLplus™, Aspen Supply Chain Analytics™, Aspen Supply Chain Connect™, Aspen Supply Planner™, Aspen Tank Management™, Aspen TASC-Mechanical™, Aspen TASC™, Aspen Teams®, Aspen Terminals Management™, Aspen TICP™, Aspen Transition Manager™, Aspen Turbo PIMS™, Aspen Utilities™, Aspen Voice Fulfillment Management™, Aspen Watch Desktop™, Aspen Watch

Server™, Aspen Water™, Aspen Web Fulfillment Management™, Aspen WinRace Database™, Aspen XPIMS™, Aspen Zyqad Development Version™, Aspen Zyqad™, SLM™, SLM Commute™, SLM Config Wizard™, the aspen leaf logo, and Plantelligence are trademarks or registered trademarks of Aspen Technology, Inc., Cambridge, MA.

All other brand and product names are trademarks or registered trademarks of their respective companies.

This document is intended as a guide to using AspenTech's software. This documentation contains AspenTech proprietary and confidential information and may not be disclosed, used, or copied without the prior consent of AspenTech or as set forth in the applicable license.

Corporate

Aspen Technology, Inc.
Ten Canal Park
Cambridge, MA 02141-2201
USA
Phone: (1) (617) 949-1000
Toll Free: (1) (888) 996-7001
Fax: (1) (617) 949-1030
URL: <http://www.aspentech.com/>

Related Documentation

Title	Content
Aspen Plus Getting Started Building and Running a Process Model	Tutorials covering basic use of Aspen Plus. A prerequisite for the other Getting Started guides
Aspen Plus Getting Started Using Equation Oriented Modeling	Tutorials covering the use of equation-oriented models in Aspen Plus
Aspen Plus Getting Started Modeling Petroleum Processes	Tutorials covering the Aspen Plus features designed to handle petroleum
Aspen Plus Getting Started Customizing Unit Operation Models	Tutorials covering the development of custom unit operation models in Aspen Plus
Aspen Plus Getting Started Modeling Processes with Electrolytes	Tutorials covering the Aspen Plus features designed to handle electrolytes
Aspen Engineering Suite Installation Manual	Instructions for installing Aspen Plus and other Aspen Engineering Suite products
Aspen Plus User Guide	Procedures for using Aspen Plus

Technical Support

Online Technical Support Center

AspenTech customers with a valid license and software maintenance agreement can register to access the Online Technical Support Center at:

<http://support.aspentech.com>

You use the Online Technical Support Center to:

- Access current product documentation.
- Search for technical tips, solutions, and frequently asked questions (FAQs).
- Search for and download application examples.
- Search for and download service packs and product updates.
- Submit and track technical issues.
- Search for and review known limitations.
- Send suggestions.

Registered users can also subscribe to our Technical Support e-Bulletins. These e-Bulletins proactively alert you to important technical support information such as:

- Technical advisories.
- Product updates.
- Service Pack announcements.
- Product release announcements.

Phone and E-mail

Customer support is also available by phone, fax, and e-mail for customers who have a current support contract for their product(s). Toll-free charges are listed where available; otherwise local and international rates apply.

For the most up-to-date phone listings, please see the Online Technical Support Center at:

<http://support.aspentech.com>

Support Centers	Operating Hours
North America	8:00 – 20:00 Eastern time
South America	9:00 – 17:00 Local time
Europe	8:30 – 18:00 Central European time
Asia and Pacific Region	9:00 – 17:30 Local time